

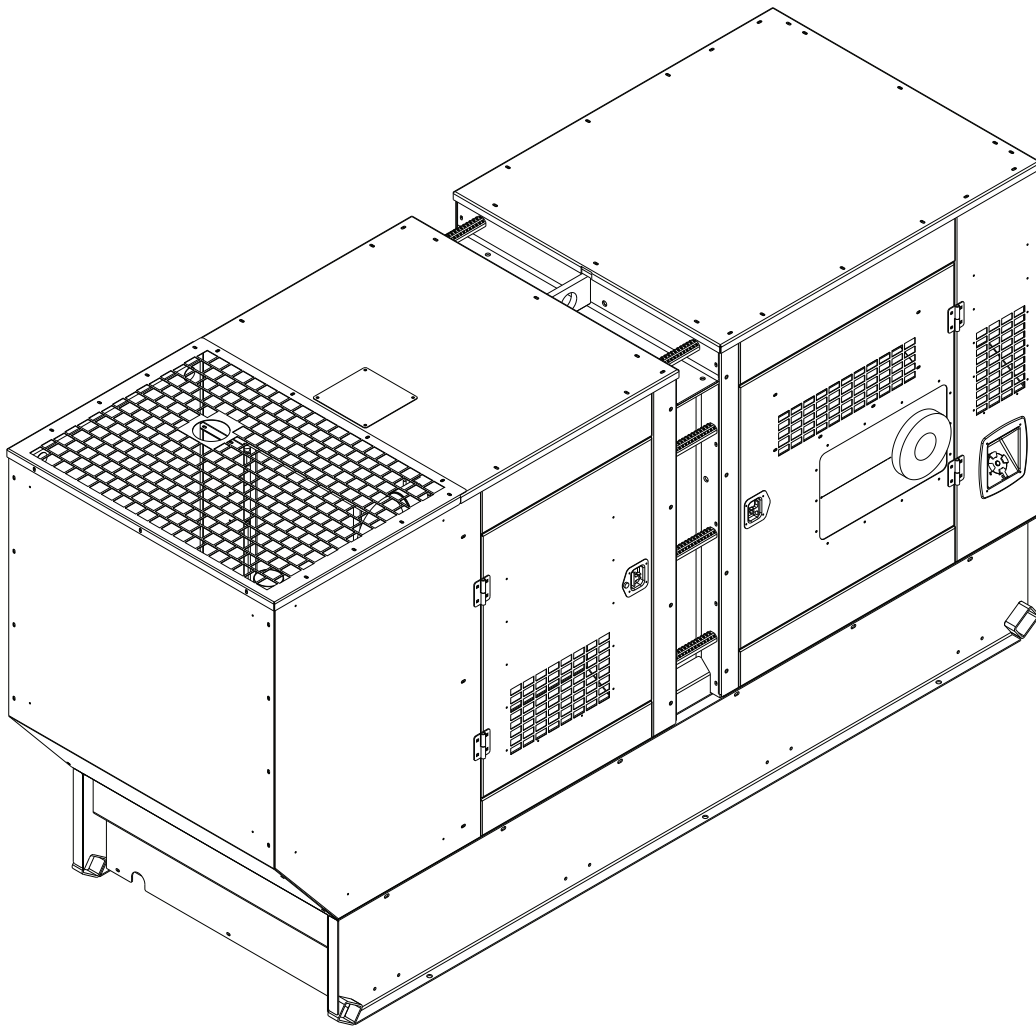

DRY-PRIME DIESEL TRASH PUMP
MTP6504NPC



OPERATING MANUAL

INTRODUCTION

This manual provides information and procedures to safely operate and maintain the engine and pump. For your own safety and protection from physical injury, carefully read, understand, and observe the safety instructions described in this manual. *The information contained in this manual was based on machines in production at the time of publication. Magnum Power Products LLC reserves the right to change any portion of this information without notice.*

DO NOT MODIFY or use this equipment for any application other than which it was designed for.

Magnum Power Products LLC recommends that a trained and licensed professional perform all electrical wiring and testing functions. Any wiring should be in compliance with the United States National Electric Code (NEC), state and local codes and Occupational Safety and Health Association (OSHA) guidelines.

Keep a copy of this manual with the unit at all times. Additional copies are available from Magnum Power Products LLC, or can be found at www.m-p-llc.com. An engine operator's manual was also supplied with the unit at the time of shipment from the factory. The manual provides detailed operation and maintenance procedures for the engine. Additional copies of the engine operator's manual are available from the engine manufacturer.

MAGNUM POWER PRODUCTS LLC

215 Power Drive • Berlin, WI 54923

U.S.A.

Phone: 920-361-4442

FAX: 920-361-4416

Toll Free: 1-800-926-9768

www.m-p-llc.com

For technical or parts **QUESTIONS**, please contact the Magnum Power Products LLC Customer Support or Technical Support team at 1-800-926-9768. Please have your serial number available.

To **ORDER SERVICE PARTS**, please contact the dealer from which you purchased the unit, or call Magnum Power Products LLC to locate a dealer in your area.

Engine Make: _____

Engine Serial Number: _____

Engine Model Number: _____

Pump Make: _____

Pump Model Number: _____

Pump Serial Number: _____

Unit Model Number: _____

Unit Serial Number: _____

▲ WARNING

CALIFORNIA PROPOSITION 65 WARNING: Diesel engine exhaust and some of its constituents are known to the state of California to cause cancer, birth defects and other reproductive harm.

TABLE OF CONTENTS

	Page
INTRODUCTION	2
SAFETY NOTES	5
OPERATING SAFETY	5
ENGINE SAFETY	6
PUMP SAFETY	6
SERVICE SAFETY	7
UNIT SERIAL NUMBER LOCATION	7
SAFETY SYMBOL SUMMARY	8
SPECIFICATIONS	9
LOCATIONS AND CONTROLS	10
CONTROL PANEL	12
CONTROL PANEL OPERATION	13
THROTTLE CONTROL	13
RAMP THROTTLE (SPEED CONTROL SWITCH)	14
AUTOMATIC START/STOP OPERATION	14
CANPLUS DISPLAY	16
ANALOG GAUGE PAGES	16
DIGITAL GAUGE PAGES	16
SINGLE ANALOG GAUGE	17
ANALOG TRANSDUCER/SWITCH GAUGE	17
DIGITAL TRANSDUCER GAUGE	17
ACTIVE ALARMS	17
ALARM LIST	18
CONFIGURATION	18
CONFIGURATION MENU	18
DISPLAY MENU	19
SYSTEM MENU	20
AUTOSTART MENU	25
SETTINGS MENU	27
TELEMETRY MENU	29
DB VIEWER	30
PREFERRED SCREEN STORE	30
POPUP MESSAGES AND ALERTS	30
ADJUSTING LIGHTING AND CONTRAST	31
INDICATORS	31
DATA PARAMETERS MONITORED	32
ENGINE BREAK-IN REQUIREMENTS	34
PUMP PRE-USE CHECKPOINTS	34
PUMP SET UP	35
STARTING THE PUMP	36
SUCTION SPECIFICATIONS	38
STOPPING THE PUMP	38
AUTOMATIC SHUTDOWN	38
REMOTE/AUTO STARTING	39
LIFTING THE PUMP	39
DAILY WALK AROUND INSPECTION	39
ENGINE AND PUMP MAINTENANCE	40
BASIC MAINTENANCE SCHEDULE (JOHN DEERE ENGINE)	40
BELT TENSION	41
SERVICING THE PUMP	41
LUBRICATION - BEARING FRAME	42
LUBRICATION - MECHANICAL SEAL OIL RESERVOIR	42
LUBRICATION - VACUUM PUMP	42
STORAGE	42
PUMP TROUBLESHOOTING	43
ENGINE FAULT SHUTDOWN TROUBLESHOOTING	44

CONTROL SYSTEM TROUBLESHOOTING 45
DC WIRING DIAGRAM 46
SERVICE LOG 47

SAFETY NOTES



This is the safety alert symbol. It is used to alert you to potential personal injury hazards. Obey all safety messages that follow this symbol to avoid possible injury or death.

This manual contains DANGERS, WARNINGS, CAUTIONS, NOTICES and NOTES which must be followed to prevent the possibility of improper service, damage to the equipment, personal injury or death. The following formatting options will apply when calling the readers attention to the DANGERS, WARNINGS, CAUTIONS, NOTICES and NOTES.

▲ DANGER

INDICATES A HAZARDOUS SITUATION WHICH, IF NOT AVOIDED, WILL RESULT IN DEATH OR SERIOUS INJURY.

▲ WARNING

Indicates a hazardous situation which, if not avoided, could result in death or serious injury.

▲ CAUTION

Indicates a hazardous situation which, if not avoided, may result in minor or moderate injury.

NOTICE

Indicates a hazardous situation which, if not avoided, may result in property or equipment damage.

Note: Notes contain additional information important to a procedure and will be found within the regular text body of this manual.

OPERATING SAFETY



Before using the pump be sure you read and understand all of the instructions! This equipment was designed for specific applications; DO NOT modify or use this equipment for any application other than which it was designed for. Equipment operated improperly or by untrained personnel can be dangerous! Read the operating instructions and familiarize yourself with the location and proper use of all instruments and controls. Inexperienced operators should receive instruction from someone familiar with the equipment before being allowed to operate or set up the pump. The following points should be practiced at all times:

- The area immediately surrounding the pump should be dry, clean, and free of debris.
- Position and operate the pump on a firm, level surface.
- **NEVER** start a unit in need of repair.
- **NEVER** modify the pump or use it in a manner other than for what it was designed.
- Do not start the pump if any panels or guards are loose or missing.
- Move the engine start switch to the "OFF" position when servicing or troubleshooting.
- Use hearing protection if you will be near an operating pump for an extended period of time.
- Keep clear of pump suction and discharge openings while the pump engine is running.
- Keep all body parts, loose clothing and any other obstructions away from moving parts.
- **NEVER** operate the unit while tired, distracted, or under the influence of drugs or alcohol.

ENGINE SAFETY



Internal combustion engines present special hazards during operation and fueling! Failure to follow the safety guidelines described below could result in severe injury or death. Also read and follow all safety warnings described in the engine operator's manual. A copy of this manual was supplied with the unit when it was shipped from the factory.

- **DO NOT** run engine indoors or in an area with poor ventilation unless exhaust hoses are used. Diesel engine exhaust contains carbon monoxide, a deadly, odorless and colorless gas which, if inhaled, can cause nausea, fainting or death. Make sure engine exhaust cannot seep into closed rooms or ventilation equipment.
- **DO NOT** fill fuel tank near an open flame, while smoking, or while engine is running. **DO NOT** fill tank in an enclosed area with poor ventilation.
- **DO NOT** operate with the fuel tank cap loose or missing.
- **DO NOT** operate on a combustible surface.
- **DO NOT** touch or lean against hot exhaust pipes or engine block.
- **DO NOT** clean air filter with gasoline or other types of low flash point solvents.
- **DO NOT** remove engine coolant cap while engine is hot.
- **DO NOT** operate the unit without a functional exhaust system. Prolonged exposure to sound levels in excess of 85 dB(a) can cause permanent hearing loss. Wear hearing protection when working around a running engine.
- Keep hands, feet and loose clothing away from moving parts on the pump and engine.
- Keep area around exhaust pipes and radiator free of debris to reduce the chance of an accidental fire.
- Batteries contain sulfuric acid which can cause severe injury or death. Sulfuric acid can cause eye damage, burn flesh or eat holes in clothing. Protective eye wear and clothing are necessary when working on or around the battery. Always disconnect the NEGATIVE (-) battery cable from the corresponding terminal before performing any service on the engine or other components.
- Shut down the engine if any of the following conditions exist during operation:
 1. Noticeable change in engine speed.
 2. Loss of pumping output.
 3. Sparking occurs.
 4. Engine misfires or there is excessive engine or pump vibration or noise.

PUMP SAFETY



Centrifugal pumps are designed for specific applications and may not be suited for other uses without loss of performance or potential damage to equipment/personnel. If there is any doubt about suitability for a specific purpose; contact Magnum Power Products LLC for assistance. Follow the safety guidelines described below to prevent hazardous situations which could result in severe injury or death.

- This pump is designed to handle mild industrial corrosives, residues and slurries containing some large entrained solids. Do not attempt to pump volatile, corrosive, or flammable materials that may damage the pump or endanger personnel as a result of pump failure.
- After the pump has been positioned, make certain that the pump and all hose/piping connections are tight, properly supported and secure before operation.
- Do not operate the pump without the guards in place over the rotating parts. Exposed rotating parts can catch clothing, fingers, or tools, causing severe injury to personnel.
- Do not remove plates, covers, gauges, pipe plugs or fittings from an overheated pump. Vapor pressure within the pump can cause parts being disengaged to be ejected with great force. Allow the pump to cool before servicing.

- Do not operate the pump against a closed discharge valve for long periods of time. If operated against a closed discharge valve, pump components will deteriorate, and the liquid could come to a boil, build pressure, and cause the pump casing to rupture or explode.
- Remove suction and discharge hoses/piping from pump prior to moving. Use lifting and moving equipment with adequate capacity and in good repair.
- Never exceed the maximum permissible operating pressure of the pump as shown on the pump performance curve.
- If equipment is stored more than 12 months, some of the components or lubricants may have exceeded their maximum shelf life. These must be inspected and replaced as necessary prior to pump operation to ensure proper pump performance.

SERVICE SAFETY



All service work must be performed by qualified personnel who are familiar with the equipment. Only a qualified electrician should troubleshoot or repair electrical problems occurring in this equipment. Follow the safety guidelines described below to prevent hazardous situations which could result in severe injury or death.

- Before servicing the trash pump, make sure the engine start switch is turned to OFF and the negative terminal on the battery is disconnected. **NEVER** perform even routine service (oil/filter changes, cleaning, etc.) unless all electrical components are shut down.
- **NEVER** service electrical components if clothing or skin is wet. If the unit is stored outside, check the engine for any moisture and dry the unit before use.
- **NEVER** open the radiator cap or oil drain plug while the engine is running or before the engine has cooled down. Pressurized coolant and hot engine oil can cause severe burns. Allow the engine and pump to cool completely before attempting any service work.
- Check the temperature before opening any pump covers, plates or plugs. Allow the pump to cool if overheated!
- Before servicing the pump end, close the suction and discharge valves. Vent the pump slowly and cautiously. Drain the pump completely.
- **NEVER** attempt to modify the engine, pump or related components.
- **NEVER** wash the unit with a power washer or high pressure hose.
- Replace all guards and safety devices immediately after servicing.
- Replace all missing and hard-to-read labels. Labels provide important operating instructions and warn of dangers and hazards.
- Make sure slings, chains, hooks, ramps, jacks, and other types of lifting devices are attached securely and have enough weight-bearing capacity to lift or hold the equipment safely. Always remain aware of the position of other people around you when lifting the equipment.

UNIT SERIAL NUMBER LOCATION

The unit ID tag can be found on top of the control box behind the control door on your unit. Important information, such as the unit serial number and model number are found on this tag. Record the information from this tag, so it is available if the tag is lost or damaged. When ordering parts or requesting technical service information, you will be asked to provide this information.

SAFETY SYMBOL SUMMARY

This equipment has been supplied with numerous safety and operating decals. These decals provide important operating instructions and warn of dangers and hazards. Replace any missing or hard-to-read decals and use care when washing or cleaning the unit. Decal placement and part numbers can be found in the parts manual. Below is a summary of the intended meanings for the symbols used on the decals.

	Safety alert symbol; used to alert you to potential personal injury hazards.		Asphyxiation hazard; operate in well ventilated area.
	Hot surface(s) nearby.		Hazardous voltage. Disconnect battery before servicing.
	Belt/entanglement hazard; keep body parts clear of this area.		Anchor/tie down point.
	Rotating fan hazard; do not operate without guards in place. Keep body parts clear of this area.		Burn/scald hazard; pressurized steam.
	Rotating impeller blade hazard; keep body parts clear of this area.		Use clean diesel fuel only.
	Moving parts can crush and cut; keep body parts clear of this area.		Remove negative battery cable before performing any service on unit.
	Stop engine before fueling.		Read and understand the supplied operating manual before operating unit.
	Hearing protection required while operating unit.		Lift here only.
	Fire/explosion hazard; keep open flames away from unit.		Crush/pinch hazard; keep body parts clear of this area.

SPECIFICATIONS

Read this manual carefully before attempting to use this equipment. The potential for property damage, personal injury or death exists if this equipment is misused or installed incorrectly. Read all of the manuals included with this unit. Each manual details specific information regarding items such as set up, use and service requirements. SPECIFICATIONS ARE SUBJECT TO CHANGE WITHOUT NOTICE.

MAGNUM MODEL

MTP6504NPC

Engine:

Make/Brand.....	John Deere
Model	6068HF485
Type	Diesel, liquid cooled, 4-stroke
Displacement in³ (L)	415 (6.8)
Cylinders - qty	6
Eng Rated Speed rpm	2400
Eng Pwr @ Rated Speed - Int. hp (kW)	275 (205)
Eng Operating Speed rpm	1800
Eng Pwr @ Oper. Speed - Int. hp (kW)	249 (186)
Fuel Consumption - 100% load gph (Lph)	15.2 (57.5)
Battery Type - Group Number	31
Battery Voltage (Quantity per Unit)	12V (1)
Battery Rating	950 CCA
Alternator Rating	65A

Pump:

Make/Brand.....	Pioneer Pump Inc.
Model	VP64S17
Fitting Size	BOLTED FLANGE
Impeller Material	CA6NM Stainless Steel
Impeller Diameter in (mm)	17.0 (432)
Shaft Material	17-4 PH Stainless Steel
Volute Material	ASTM A536 Ductile Iron
Wear Plate Material.....	ASTM A48 Ductile Iron

Pump Set (Engine/Pump):

Maximum Diameter of Solids in (mm)	3.0 (76.2)
Maximum Pump Output gpm (Lpm)	2740 (10372)
Maximum Lift Suction ft (m)	25 (8)
Maximum Operating Speed rpm	1800
Total Dynamic Head ft (m)	368 (112)
Sound dB(a) 23 ft. @ prime	68.1

Dimensions (LxWxH):

Skid Mounted in (m)	132 x 50 x 77 (3.35 x 1.27 x 1.96)
----------------------------------	------------------------------------

Weights:

Dry Weight, Skid Mounted lbs (kg)	5726 (2597)
Operating Weight, Skid Mounted lbs (kg)	8316 (3772)

Capacities:

Fuel Tank Volume gal (L)	342 (1295)
Usable Fuel Volume gal (L)	313 (1185)
Maximum Run Time hrs	21

LOCATIONS AND CONTROLS

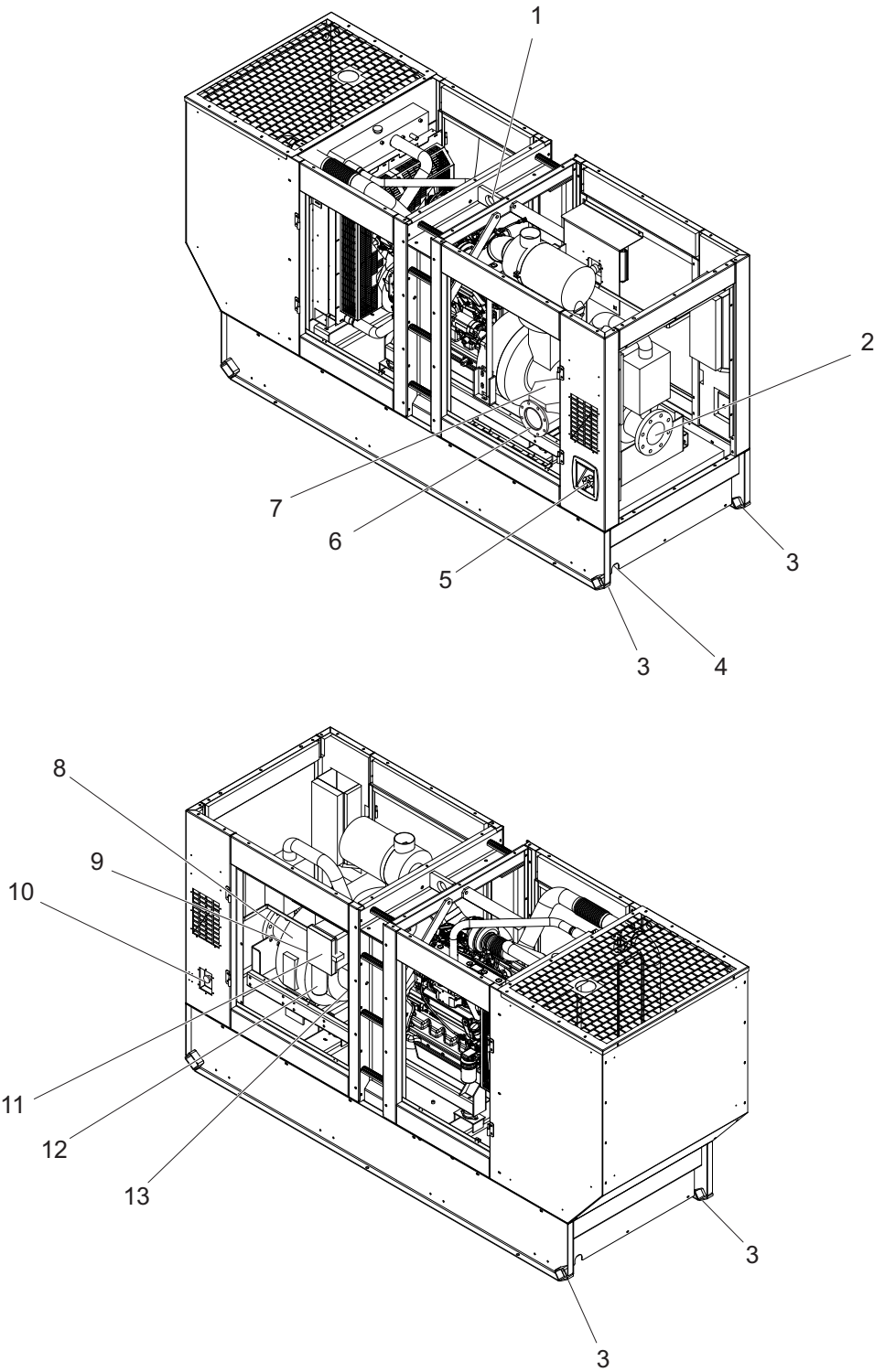

1. **CENTRAL LIFT EYE.** Used for lifting the pump.
2. **PUMP INLET (SUCTION) PORT.** Opening for intake of liquids into the pump. Fittings can be threaded or bolted to the pump flange.
3. **TIE-DOWN LOCATIONS.** Used to secure the pump for storage and/or transport.
4. **FUEL TANK DRAIN.** Remove plug to drain tank for cleaning and/or maintenance.
5. **FUEL FILL PORT.** Lockable port for filling the fuel tank with clean diesel fuel.
6. **PUMP OUTLET (DISCHARGE) PORT.** Opening for discharge of liquids from the pump. Fittings can be threaded or bolted to the pump flange.
7. **CHECK VALVE.** A valve that permits flow in one direction only (required for pump priming).
8. **PUMP VOLUTE (HOUSING).** Cast-iron housing for pump mechanical components.
9. **FUEL GAUGE.** Displays the amount of fuel remaining in the fuel tank (located near the control panel).
10. **EMERGENCY STOP.** Activate the emergency stop switch by pushing the red button in until it locks down. Only use when the pump must be shut down immediately. For any other shut down, follow the procedure on [page 38](#).
11. **CONTROL PANEL.** Controls and indicators for pump operation.
12. **MECHANICAL SEAL OIL SIGHT TUBE.** See [page 42](#) for more information.
13. **BEARING OIL SIGHT GLASS.** See [page 42](#) for more information.

Note: Use hoses and fittings that are specifically designed and sized for this type of equipment.

CONTROL PANEL

The CANplus® 750 (CP750™) control panel is a universal platform to monitor, control and automatically start/stop both electronically and mechanically governed diesel engines. The microprocessor-based, solid-state design uses high power semiconductors instead of electromechanical relays to ensure reliable high current switching. Graphical gauge pages or a single large analog gauge are displayed on the 4.25" diagonal LCD. Virtually any SAE J1939 parameter reported by the Engine Control Unit (ECU) can be displayed including RPM, coolant temperature, oil pressure, engine hours, voltage and diagnostic codes. The trans-reflective, backlit display is clearly readable in both bright sunlight as well as total darkness and is housed in a rugged IP67 rated housing.

Current alarm conditions are displayed in plain language on popup messages and can be viewed in the alarm list. Various diagnostic screens allow detailed investigation of the CANbus data stream. By accessing the *Configuration Menu*, users can customize displayed data to show metric or US units, display language and various other parameters such as the full-scale reading of gauges. Four bright LEDs below the display indicate Auto Standby, Preheat, Stop and Warning status.

Five buttons access a context dependent *button bar* when any button from 1 to 4 is pressed. The graphical menu structure uses icons to indicate the button's current function. After five seconds of inactivity the button bar disappears.



Button 1	Button 2	Button 3	Button 4	Button 5
<p>Analog Gauge Pages</p> <p>Press repeatedly to cycle through four pages of analog gauges (16 total)</p>	<p>Digital Gauge Pages</p> <p>Press repeatedly to cycle through four pages of digital gauges (16 total)</p>	<p>Single Analog Gauge</p> <p>Press repeatedly to cycle through available analog gauges.</p>	<p>Active Alarm Page</p> <p>Displays active alarms including a plain language description.</p>	<p>Gauge Adjust</p> <p>Configures the parameters displayed by gauge pages.</p>

Note: Most problems with electronically controlled engines can be pinpointed via ECU diagnostic messages. Use the display or ECU diagnostic tool to view fault codes. Engine state information and diagnostic codes displayed by the CANplus display are provided via the CANbus.

AUTOMATIC OPERATION

The CP750 panel features advanced Automatic Start/Stop controls which can meet almost any requirement. Two switch inputs and a transducer input support a number of control scenarios. Single switch mode allows reliable operation with a single switch. Dual switch operation allows greater hysteresis when needed.

The transducer input supports simple start/stop operation by level or pressure and maintenance modes with speed modification.

- Programmable high and low set points control start/stop operation.
- Level maintenance modes monitor the operating point and adjust the engine speed to match the targeted set point with configurable aggressiveness.
- Dual switch inputs can be combined with the transducer input for redundant safety to protect against transducer sensor clog or failure.

THROTTLE CONTROL

The standard *Ramp Throttle* uses a momentary rocker switch to adjust the integral throttle control. All throttle commands are sent directly to the engine using CANbus throttle control.

SERVICE TIMERS

The CP750 display provides 16 service timers to alert the operator of needed maintenance. The time interval for each timer can be adjusted in 10 hour increments. A popup message is displayed after the display self test if a timer has expired alerting the user that service is required. The message is displayed on each power up until the elapsed timer is disabled or reset.

CANPLUS MESSENGER TELEMETRY OPTION

The optional *CANplus Messenger* system provides a variety of features to protect and support the equipment investment. Remote monitoring can alert maintenance requirements, operational problems, improper operation and location with geo-fence alert. The Web-browser interface allows monitoring an entire fleet of equipment in a central location. Contact Magnum Power Products LLC for more information.

CONTROL PANEL OPERATION

Turning the control system key to the run position energizes the ECU, all LEDs illuminate once and a start-up screen is displayed while a self test is performed. If the display beeps for longer than 1 second, it indicates a self test fault. Users can attempt to rectify the fault by restoring factory defaults (see *Configuration Menu* for details). Contact Magnum Power Products LLC for assistance if the fault persists.

After the start-up screen is cleared, the display shows readings on its virtual gauges. Initially the analog gauges are displayed but the display uses the last displayed screen on subsequent startups (see *Preferred Screen Store* for details).

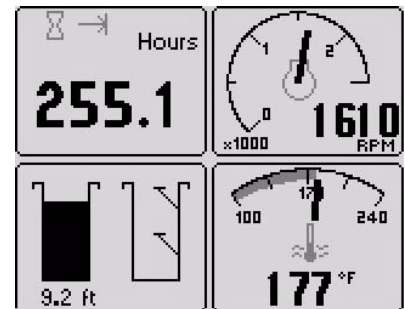

If the ECU is preheating when the key switch is turned to the run position, the *Preheat LED* is illuminated. Preheat time varies with atmospheric and engine conditions. After waiting for the *Preheat LED* to extinguish, the engine is cranked by turning and holding the key switch in the start position until the engine starts.

Note: *The ECU will not preheat unless conditions warrant. If necessary, starting the engine may be attempted by turning the key to the start position without waiting for preheat to expire.*

The key switch is spring loaded to return automatically to the run position when released. The key switch includes an interlock to prevent the key from being turned to the start position while the engine is running. The key switch must be turned to the off position to reset the starter interlock before the switch can be turned to the start position again.

THROTTLE CONTROL

The type of throttle operators installed along with the configured values of Minimum Requested RPM, Idle RPM, Intermediate RPM, Run RPM and Maximum Requested RPM determine throttle operation. The engine speed can be adjusted above Run RPM and below Idle RPM but the requests can not fall below Minimum Requested RPM or above Maximum Requested RPM. The ECU determines how the engine responds to the throttle requests and will

not allow the engine speed to fall below the ECU minimum or exceed the maximum RPM.

Note: The Minimum Requested RPM and Maximum Requested RPM can only be configured using the CANplus Configurator. See Configuration below for more information.

RAMP THROTTLE (SPEED CONTROL SWITCH)

The standard *Ramp Throttle* uses a momentary rocker switch to adjust the requested engine speed. When first started the requested engine speed is *Idle RPM*. Pressing and releasing the rabbit 🐰 icon increases the speed requested by 25 rpm. Pressing and holding the rabbit icon causes the speed to accelerate to full speed in a few seconds. Similarly, pressing the turtle 🐢 icon decreases the requested speed.

AUTOMATIC START/STOP OPERATION

Turning the control system key to the Autostart position causes all LEDs to illuminate once, the *Auto Standby* indicator is illuminated and the start-up screen is displayed while a self test is performed. After the start-up screen is cleared, the display shows the transducer reading and switch status on the *Transducer/Switch* gauge. All other CANbus values will show **---** since the ECU is not energized at this time. After one minute, the display is powered down to reduce battery drain. The automatic start/stop system is still functioning as indicated by the *Auto Standby* LED.

Once the configured automatic start condition exists, the display powers up, the panel starts the engine and follows the throttle control profile configured (see diagram). The flexible throttle profile includes various speeds and times for a variety of scenarios.

When the configured stop conditions exist, the panel reduces the engine speed per the throttle profile and stops the engine. If the configured start conditions exist before the shutdown process is complete, the engine will return to the previous speed until the stop condition exists.

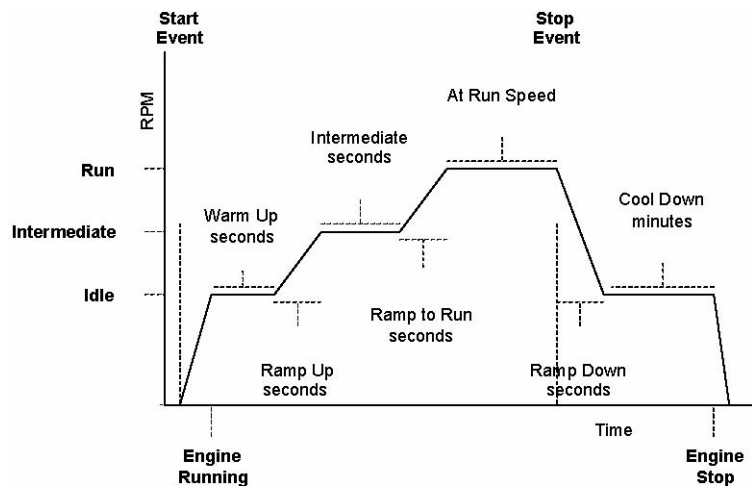

⚠ WARNING

When the key is turned to the autostart position and a start condition exists, the panel will start *immediately!* Always configure parameters by turning the key to run. Do not configure the panel in the autostart position! Always use lock out/tag out procedures when servicing autostart equipment!

START AND STOP EVENTS

The Start and Stop Events are determined by the combination of Start/Stop Mode and Function. See the table below for:

START/STOP MODES

Sngl Switch Switch one controls automatic operation.

Dual Switch Both switch inputs control automatic operation.

Transducer The transducer input controls automatic operation.

Xducer & Sw The transducer input controls automatic operation with dual switch mode as the backup. The switch inputs override the transducer if actuated when the transducer is not calling for an automatic cycle.

START/STOP FUNCTIONS

Empty Uses the selected mode to *reduce* the level or pressure.

Fill Uses the selected mode to *increase* the level or pressure.

Maintain Out Uses the transducer to maintain the level or pressure at or *below* the target.

Maintain In Uses the transducer to maintain the level or pressure at or *above* the target.

Mode ▼	Function ►	Empty	Fill	Maintain Out	Maintain In
Sngl Switch	Start	SW1 Close	SW1 Open		
	Stop	SW1 Open	SW1 Close		
Dual Switch	Start	SW1 and SW2 Close	SW1 and SW2 Open		
	Stop	SW1 and SW2 Open	SW1 and SW2 Close		
Transducer	Start	Above High Set Point	Below Low Set Point	Above High Set Point	Below Low Set Point
	Stop	Below Low Set Point	Above High Set Point	Below Low Set Point	Above High Set Point
Xducer & Sw	Start	Above High Set Point or SW1 and SW2 Close	Below Low Set Point or SW1 and SW2 Open	Above High Set Point or SW1 and SW2 Close	Below Low Set Point or SW1 and SW2 Open
	Stop	Below Low Set Point or SW1 and SW2 Open	Above High Set Point or SW1 and SW2 Close	Above High Set Point or SW1 and SW2 Close	Below Low Set Point or SW1 and SW2 Open

Note: When the switch inputs are the source of the start event in Xducer & Sw mode, only the switches will stop the engine.

MAINTAIN FUNCTIONS

The *Maintain In* and *Maintain Out* functions adjust the engine speed to keep the transducer level at the *Target Set Point*. The *Servo Gain* adjusts how aggressively the throttle is adjusted while the *Servo Delay* controls how often the throttle is adjusted.

Note: Maintain functions are only available in the Transducer or Xducer & Sw modes.

The direction of the throttle adjustment is dependent on the selected mode as shown in the table.

Transducer State	Maintain Out	Maintain In
Above Target	Increase Speed	Decrease Speed
Below Target	Decrease Speed	Increase Speed

DEAD BAND

In some situations, the transducer level may fluctuate around the *Target Set Point*. To limit throttle hunting using the maintain functions a dead band can be programmed. This value prevents throttle adjustment while the level is within the band (see diagram). In essence, the speed is considered to be at the target whenever it is within the dead band.

Note: The dead band entered is amount above and below the target point. For example, if the target is 5.0 feet with a 0.1 foot dead band, the dead band is 4.9 to 5.1 feet.

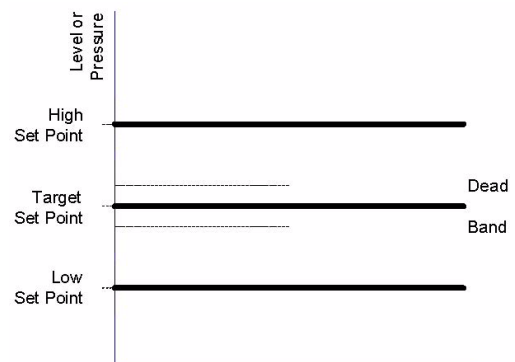

CANPLUS DISPLAY

Soft buttons simplify the user interface by displaying a *button bar* above the buttons when any of the first 4 buttons (buttons 1 to 4, starting from the left) are pressed. Icons on the button bar change to represent the current function of each button. The button bar disappears after 5 seconds if no further buttons are pressed.

Note: Different software versions may have slightly different displays.



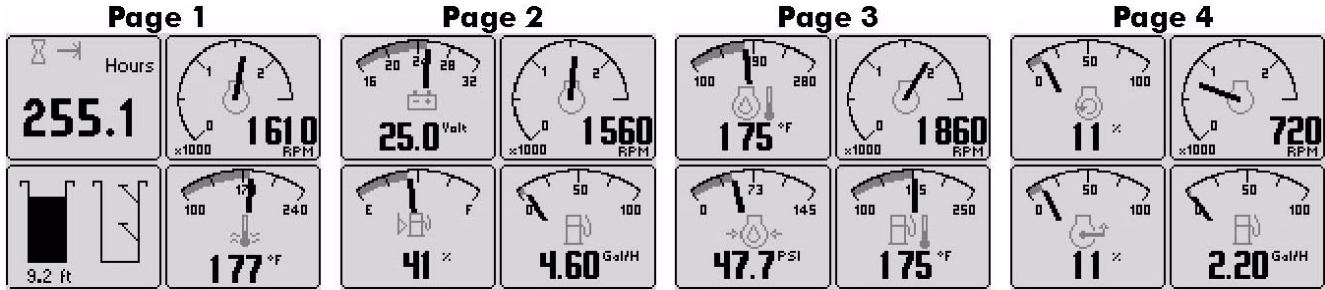

ANALOG GAUGE PAGES

Analog Gauge Pages provide four independent pages of analog gauges. To enable Analog Gauge Pages, press any of the first four buttons to show the top level button bar and then press button 1 . Alternate pages are selected by repeated pressing of button 1. The four standard gauge pages are shown below.



Note: Engine Hours are displayed as a digital value even on Analog Gauge Pages. The default gauge pages represent 13 selections since the tachometer is repeated in the upper right quadrant of each page.

All 16 gauges may be configured by the user to create an application-specific view of CANbus data. Gauges on the current page can be changed via *Adjust Mode*, accessed by pressing button 5  when the button bar is visible. Gauges can be changed on any of the four pages by selecting the page to be changed and then entering *Adjust Mode*.

In *Adjust Mode* a new button bar is displayed identifying the button functions. Button 1  corresponds to the upper left gauge, button 2  to the upper right gauge, button 3  to the bottom left gauge and button 4  to the bottom right gauge. Successive presses of the buttons selects a different parameter for the gauge. *Adjust Mode* is exited by pressing button 5  and storing the new configuration even when power is removed.



Note: A gauge selection can only appear once per page. To move a gauge selection, the existing gauge location must be changed first. Gauge selections are limited to the data currently being received. Gauge pages can be configured in *Demo mode* to select any supported parameter. See *Data Parameters Monitored* for a complete list of available parameters.

Adjust Mode can be disabled in the *Configuration Menu* to prevent accidental changes.

DIGITAL GAUGE PAGES

Digital Gauge Pages display the same data as the Analog Gauge Pages but in digital only format. To enable Digital Gauge Pages, press any of the first four buttons to show the top level button bar and then press button 2 . Alternate pages are selected by repeated pressing of button 2. The four standard gauge pages are shown below.

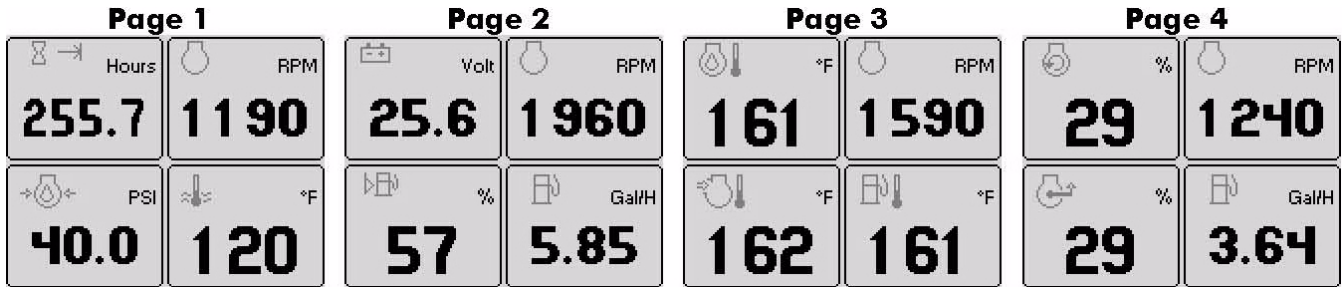

Note: The 16 gauges are the same for Analog and Digital Gauge Pages. Adjustments in either Analog Gauge Pages or Digital Gauge Pages affect the same gauge in the other mode.

SINGLE ANALOG GAUGE

Single Analog Gauge uses the entire display for a single large analog gauge. This mode is enabled by pressing any of the first four buttons to show the top level button bar and then press button 3. The gauge displayed is selectable by repeatedly pressing button 3 while in the Single Analog Gauge mode while the menu bar is visible. The currently displayed gauge is stored when power is removed (see Preferred Screen Store).

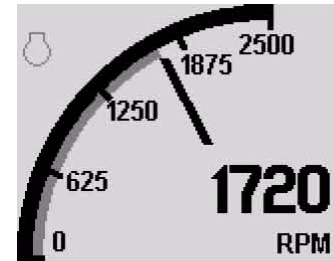

Note: Gauge selections are limited to the data currently being received. See Data Parameters Monitored for a complete list of available parameters.

ANALOG TRANSDUCER/SWITCH GAUGE

The Analog Transducer/Switch Gauge displays the transducer value and the switch input states. The left column represents the values as a bar graph with a digital value displayed below. The right column shows whether the switches are 'open' represented by the pointer being down or 'closed' represented by the pointer being up.

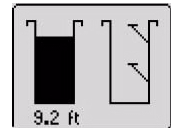

DIGITAL TRANSDUCER GAUGE

The Digital Transducer Gauge displays the transducer value as a digital only value. The switch state is not displayed on the Digital Transducer Gauge.



ACTIVE ALARMS



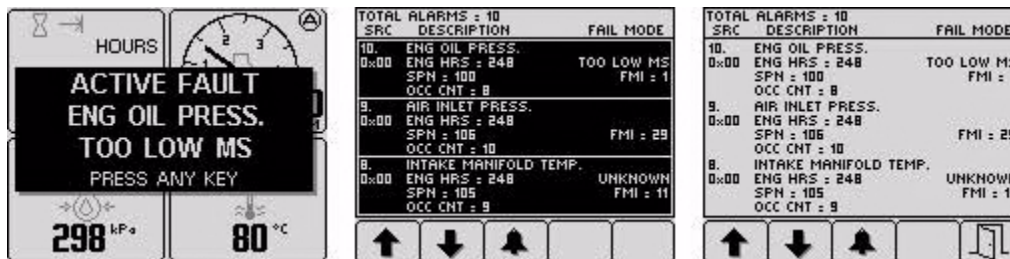

A flashing popup window is overlaid on the current screen when an active alarm is received. The popup includes a plain language description in addition to the standard SPN/FMI (Suspect Parameter Number/Failure Mode Indicator) pair defined by the SAE J1939 standard. Additionally, if enabled, the beeper sounds as an audible cue.



Example alarm message, alarm list screens showing unacknowledged conditions and acknowledged alarms. After acknowledgement, the exit button becomes active.

Note: Standard J1939 abbreviations are used for alarms. MS = Most Severe, MOD= Moderately Severe, LS = Least Severe.

ALARM LIST

The Alarm List is accessed by pressing any button while an alarm popup is displayed or by pressing any of the first 4 buttons to show the button bar and then button 4 . Alarms not yet acknowledged are shown in gray on black while acknowledged alarms are shown in black on gray. The list also indicates when the alarm occurred if engine hours are available. The most recent alarm is displayed at the top of the list. The list can be scrolled using buttons 1  and 2  and alarms acknowledged by pressing button 3 . The Alarm List can be closed by pressing button 5  once the alarms are acknowledged.





An alarm indicator  is displayed near the upper right corner of the display as long as alarms are active. The indicator and alarm messages in the list are automatically removed when the alarm is no longer received for a few seconds.

Note: Only active faults are displayed in the alarm list. Once a fault is corrected, it is automatically removed from the list. To view previously active faults, use the engine diagnostic tool.

CONFIGURATION

To adapt the CP750 panel to the requirements of a particular application, a large number of parameters are configurable. The most commonly modified parameters can be accessed by invoking the *Configuration Menu* of the display. Infrequently changed parameters and those parameters that typically need to be restricted such as Maximum RPM are accessible only through the *CANplus Configurator*. The *CANplus Configurator* is a Windows® PC program and a hardware adapter that allows total access to the parameters of the panel. For more information about the *CANplus Configurator*, please contact Magnum Power Products LLC.

CONFIGURATION MENU

This *Configuration Menu* allows the user to set various operating parameters such as US or metric units, scale limits for tachometer and service timers. The configuration menu is entered by pressing and holding button 5 (the right hand button) in any mode for at least 3 seconds. If PIN (Personal Identification Number or 'password') entry is enabled, the correct PIN must be entered to access the configuration menu. The top level configuration menu is displayed as shown. Buttons 1  and 2  allow you to choose from *Display*, *System*, *Autostart*, *Settings*, *Telemetry* or *Db Viewer*. Pressing button 4  selects the chosen menu item indicated by bold text and the selection arrow . Each item is described in detail on the following pages. Settings are automatically stored when exiting the current menu even when power is removed.

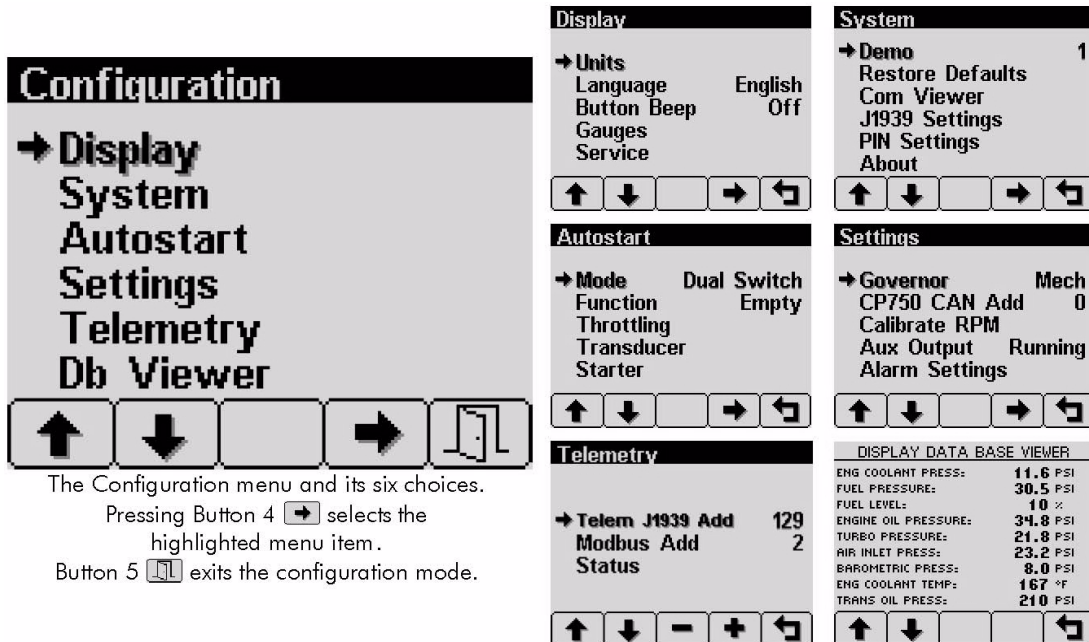

The Configuration menu and its six choices.

Pressing Button 4  selects the highlighted menu item.

Button 5  exits the configuration mode.

Display	
→ Units	English
Language	Off
Button Beep	
Gauges	
Service	

System	
→ Demo	1
Restore Defaults	
Com Viewer	
J1939 Settings	
PIN Settings	
About	

Autostart	
→ Mode	Dual Switch
Function	Empty
Throttling	
Transducer	
Starter	

Settings	
→ Governor	Mech
CP750 CAN Add	0
Calibrate RPM	
Aux Output	Running
Alarm Settings	

Telemetry	
→ Telem J1939 Add	129
Modbus Add	2
Status	

DISPLAY DATA BASE VIEWER	
ENG COOLANT PRESS:	11.6 PSI
FUEL PRESSURE:	30.5 PSI
FUEL LEVEL:	10 %
ENGINE OIL PRESSURE:	34.8 PSI
TURBO PRESSURE:	21.8 PSI
AIR INLET PRESS:	23.2 PSI
BAROMETRIC PRESS:	8.0 PSI
ENG COOLANT TEMP:	167 °F
TRANS OIL PRESS:	210 PSI

Note: Most configuration changes take affect immediately. Some, such as Idle RPM, take affect on the next power up.

DISPLAY MENU

The *Display Menu* allows the user to configure items affecting how information is displayed.

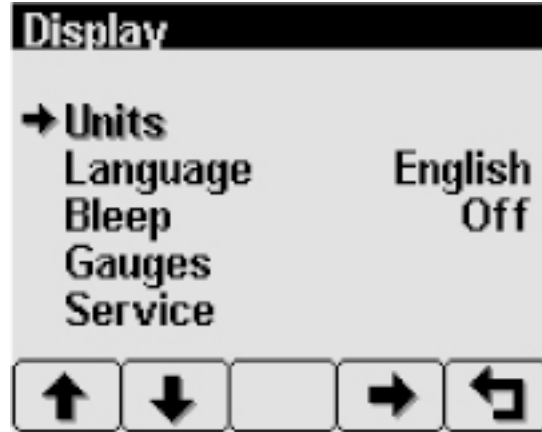

UNITS MENU

This menu allows the user to set the units used for speed, distance, pressure, volume and temperature independently. Button 4 cycles through the available values for the selected item.

Speed MPH (miles per hour); km/h (kilometers per hour); Knts (knots)
Distance Miles; km (kilometers); NM (nautical miles)
Pressure PSI (pounds per square inch); bar (barometric units); kPa (kilopascals)
Volume Gal (US gallons); lGal (Imperial gallons); Liters
Temperature °F (Fahrenheit); °C (Celsius).

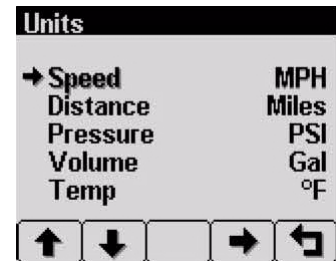

LANGUAGE MENU

This menu allows the user to choose between English, Swedish, French, German, Spanish, Italian, Dutch and Portuguese. The currently selected value is indicated by the check mark . Button 4 selects the highlighted value.

BUTTON BEEP

The soft buttons emit an audible beep when this item is On. Button beep is disabled by setting this item to Off. The audible beep still sounds when an alarm occurs. Button 4 cycles between On and Off.



GAUGES MENU

This menu allows the user to configure aspects of the gauges displayed. Button 3 selects the previous value while button 4 selects the next value of the highlighted item.

MAX RPM

Sets the full scale RPM indicated by the tachometer gauge.

RPM 2500, 3000, 3500, 4000, 4500, 5000, 6000, 7000, 8000 or 9000

MAX SPEED



Sets the full scale speed indicated by the speedometer gauge.

MPH 15, 20, 25, 30, 35, 40, 45, 50, 55, 60, 70, 75, 80, 85, 95 or 100

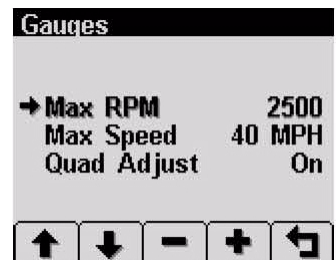
km/h 20, 30, 40, 50, 60, 70, 80, 90, 100, 110, 120, 130, 140, 150 or 160







QUAD ADJUST

Allows the user to disable *Adjust Mode* of the Analog and Digital Gauge Pages. Button 3  disables while button 4  enables Quad Adjust. Disabling *Adjust Mode* locks the current gauge configuration and prevents the operator from accidentally changing the gauge configuration.

SERVICE

Sets the 16 service intervals in hours and resets the service timer. Setting the service interval to 0 disables the timer and the word *Off* is displayed.

Pressing button 4  allows adjusting the selected service timer.

Button 1  decreases the service interval time while button 2  increases the service interval time in 10 hour increments. Holding button 3  for approximately 3 seconds resets *Next Service In* to the current service interval. The service timer descriptions can be changed using the *CANplus* Configurator.

Note: *It is not possible to set the service timers if engine hours are not being received by the display.*

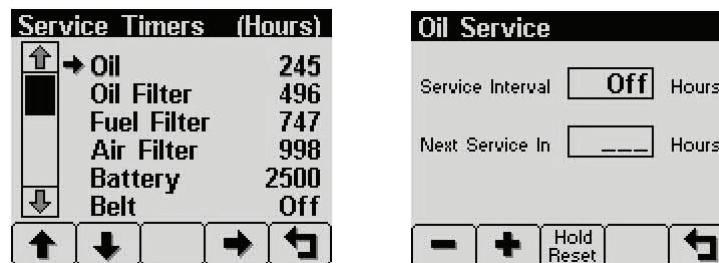

SYSTEM MENU

The *System Menu* allows the user to configure items affecting how the system functions. Button 4  cycles through the available values for the selected item.

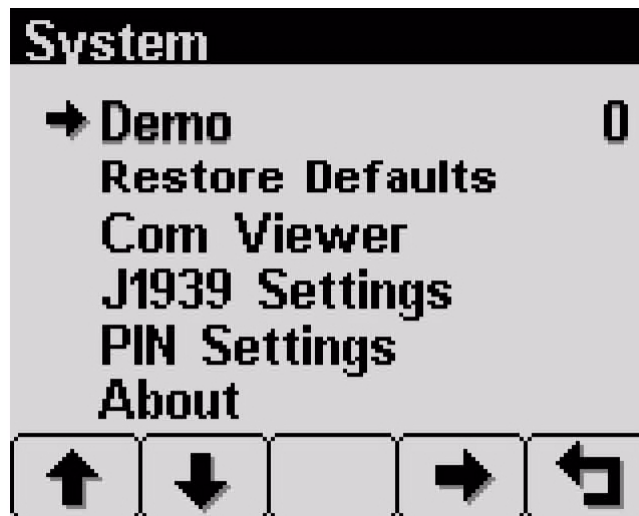

DEMO

The display supports several demo modes to operate with simulated data. Mode 1 simulates speed data and engine parameters. Mode 2 only simulates engine parameters. Mode 3 simulates speed data, engine parameters and alarms. Mode 0 disables Demo Mode. Demo is automatically set to 0 (Off) if live data is received.

RESTORE DEFAULTS

This allows resetting all configuration information to default US or Metric units. Additionally, the display is reset to the initial configuration.

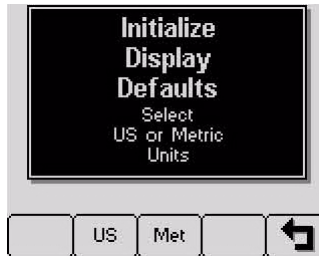

The default settings are:

Setting	US	Metric
Language	English	
Button Beep	On	
Service Timers	Off	
Display Mode	Analog Gauges	
Gauge Pages	Defaults	
Quad Adjust	On	
Demo Mode	0 (Off)	
Engine Source	0	
Display CAN Address	40	
Alarm Filter	Glb	
SPN Version	1	
Speed Source	Auto	
PIN Entry	Off	
PIN	1111	
Max Gauge RPM	2500	
Max Gauge Speed	40 MPH	60 km/h
Speed Units	MPH	km/h
Distance Units	Miles	km
Pressure Units	PSI	kPa
Volume Units	Gal	l
Temperature Units	°F	°C

COM VIEWER



Displays CANbus data received and engine configuration transmitted by the ECU.



J1939 VIEWER

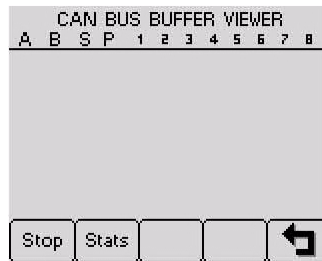

This screen provides a hexadecimal dump of the messages received on the CANbus. This viewer displays the raw data. To see the decoded data, use the *Db Viewer*.

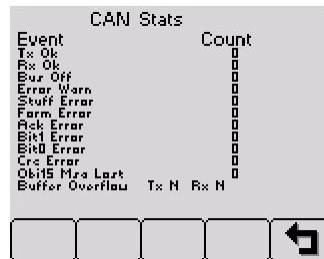

Button 1  freezes the display while button 2  shows CANbus data statistics screen.



ENGINE CONFIG

This screen displays the engine configuration information received from the ECU. Button 2  selects the next page of engine configuration while button 1  selects the previous page.

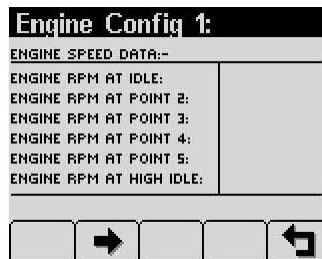

J1939 SETTINGS

This screen allows adjustments specific to the J1939 data link.

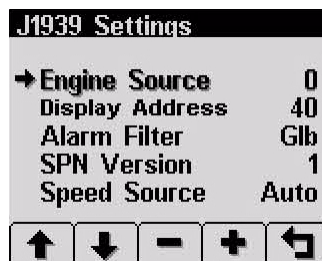

ENGINE SOURCE

Selects which source the display listens to for gauge data. Every device on a J1939 network has a unique address (in the range 0-254) to which the display can choose to listen. The display listens to a single data source; usually the ECU at address 0.

Note: *Incorrectly configuring the Engine Source address will result in no data available for display.*

DISPLAY CAN ADD

As mentioned previously, every device has a unique address and the display is no different. The default display address is 40, the recommended address for single engine setups.

Note: *Incorrectly configuring the Display Address can result in data collisions on the CANbus.*

ALARM FILTER

This setting specifies whether the display will display alarms from all sources (*Glb* or global) or only the source address specified in the *Engine Source* setting (*Src* or source).

SPN VERSION

Selects the default SPN (Suspect Parameter Number) conversion method version to 1, 2 or 3. Version 4 is automatically detected, but older engines that use conversion method 1, 2 or 3 requires setting this parameter correctly.

Note: *Consult your engine supplier to establish the appropriate SPN conversion method version. Selecting the wrong version will cause alarm data to be displayed incorrectly.*

SPEED SOURCE

There are 3 sources of speed data the display can decode. The settings for this parameter are *AUTO*, *NMEA*, *WHEEL*, *NAV* and *OFF*. *AUTO* prioritizes the sources (highest to lowest); *NMEA*, *WHEEL* (PGN 65265), *NAV* (PGN 65272). The selection can be forced to one of the available sources by selecting it explicitly. Selecting *OFF* stops the display listening to any source of speed data.





PIN SETTINGS

By default, PIN security is disabled. The user is prompted to enter a PIN every time the *Configuration Menu* is accessed after this feature is enabled.

PIN ENTRY

This allows turning PIN Entry *On* or *Off*. To enable the PIN entry feature, select *PIN Settings* and press button 4 to enable. The current pin must be entered (default is 1111) as a security feature. Once the PIN has been entered, the feature is enabled. PIN Entry is disabled by setting PIN Entry to *Off*.

The digits of the PIN are entered by using the buttons corresponding to the digits of the PIN.

Button 1  adjusts the first digit of the PIN. Button 2  adjusts the second digit, button 3  the third digit and button 4  the fourth digit. The PIN is entered using button 5 .

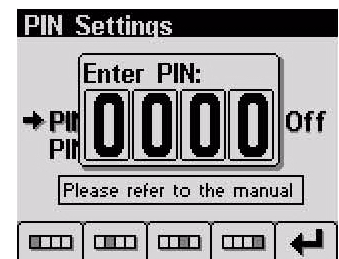
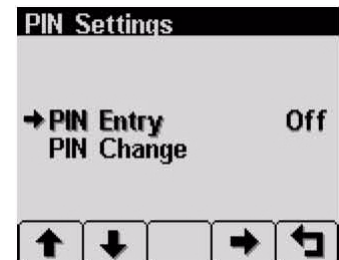

PIN CHANGE

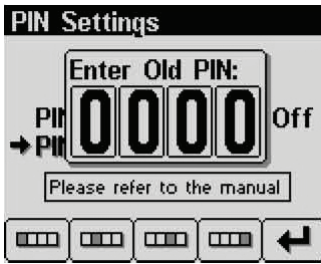

This allows changing the PIN.
The user is prompted for the current PIN.

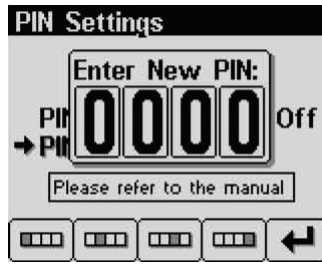

The user is prompted for the new PIN.

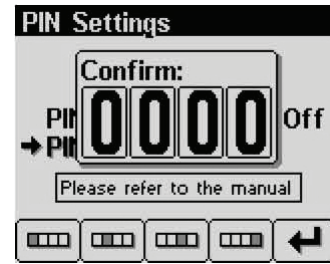

The new PIN must be confirmed before the PIN is changed.

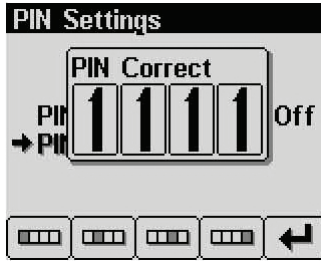

If the new PINs match, a confirmation screen is displayed.

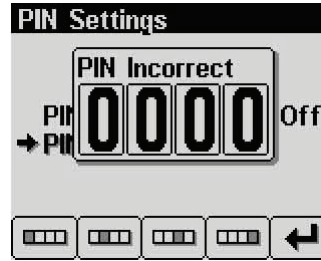

If the two PINs do not match, an error message is displayed and the PIN is unchanged.

⚠ WARNING

If the PIN is changed from the default and the new PIN is lost, the configuration mode will not be accessible. Clearing the PIN requires returning the display to LOFA Industries Inc. for service. TEL 770-569-9828

ABOUT

Displays the following product information:

- ID/Build** Serial number of the display
- EEPROM** Number of writes on EEPROM
- PART No** Unit part number
- VERS** Software version number
- CHK** Flash memory checksum
- SOURCE** The source of received data
- LIB1** Low level system library version
- LIB2** Low level Graphical Display Interface library version (if used)



Note: This screen can not be exited until the checksum calculation is complete. Checksum calculation takes approximately 10 seconds and is complete when the checksum value changes from Calculating... to a hexadecimal value such as 0x704E – OK.

AUTOSTART MENU

This submenu allows the user to configure automatic start/stop operation. Refer to *Automatic Start/Stop Operation* for more information.

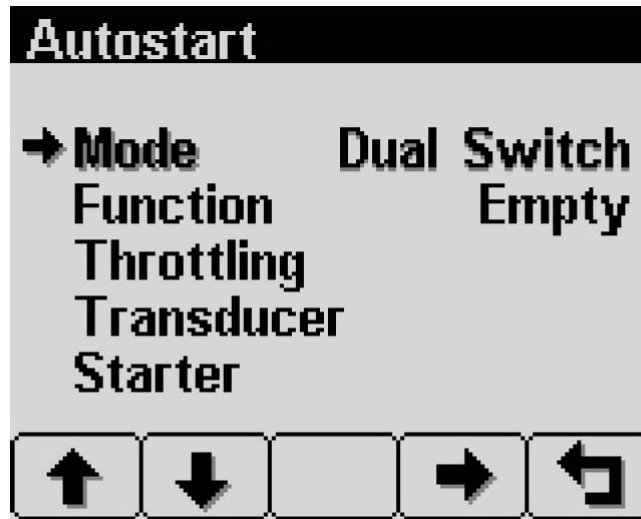

MODE

This menu selects the basic automatic start/stop operation mode. Button 4 cycles between *Single Switch*, *Dual Switch*, *Transducer* or *Xducer & Sw*.

FUNCTION

This menu selects the automatic start/stop function. Button 4 cycles between *Empty*, *Fill*, *Maintain Out* and *Maintain In*.

THROTTLING MENU

The throttling menu allows the user to configure throttle control. It also allows programming the automatic start/stop throttle profiles as shown in the following diagram.

IDLE RPM

Selects the RPM the control system will request for idle speed. Idle can be set to compensate for parasitic loads such as hydraulic pumps or compressors. Idle RPM is the low speed setting of the optional two state or three state throttle switches.



Throttling	
→ Idle RPM	800
Intermediate RPM	1400
Run RPM	1800
Ramp Up/Down	
Servo	

Note: The minimum engine speed is set by the ECU. Requesting a lower speed causes the engine to run at the ECU minimum speed. RPM limits are programmed into the panel to limit the requested speed. Changing the panel Minimum Requested RPM and Maximum Requested RPM requires using the CANplus Configurator.

INTERMEDIATE RPM

Selects the RPM the control system will request for intermediate speed. The intermediate speed can be used to prime pump or charge lines during automatic start/stop operation. Intermediate RPM is also the middle setting of optional three state throttle switches.

Note: Setting the Intermediate RPM to the same speed as Idle RPM and Ramp to Run to 0 seconds is effectively two speed automatic operation.

RUN RPM

Selects the RPM the control system will request for run speed. The run speed is the normal operating speed during automatic start/stop operation. Run RPM is the high speed setting of the optional two state or three state throttle switches.

RAMP UP/DOWN

This submenu configures the speed profile for automatic start/stop operation.

Warm Up s

Selects the number of seconds to operate at idle speed before beginning the ramp to intermediate speed. The warm up time begins when the starter is disengaged.

Ramp Up s

Selects the number of seconds to ramp from idle speed to intermediate speed after warm-up.

Intermediate s

Selects the number of seconds to operate at intermediate speed before ramping to run speed.

Ramp to Run s

Selects the number of seconds to ramp from intermediate speed to run speed after intermediate warm-up.

Ramp Down s

Selects the number of seconds to ramp from current speed to idle speed. The ramp down time begins when the automatic start/stop system detects a stop event.

Cool Down min

Selects the number of minutes to operate at idle speed after ramp down time. At the end of the cool down period, the engine will be stopped.

Ramp Up/Down	
→ Warm Up s	0
Ramp Up s	0
Intermediate s	0
Ramp To Run s	0
Ramp Down s	0
Cool Down min	0

↑ ↓ - + ↶

SERVO

Configures the servo profile for autostart maintain modes.

Gain

Controls the aggressiveness of the maintain servo modes.

Delay 10mS

Controls how quickly the maintain servo mode responds to changes in level.

Servo	
→ Gain	5
Delay 10mS	1

↑ ↓ - + ↶

TRANSDUCER

This submenu configures the transducer type and set points.

Type

Selects between Level and Pressure CANplus Configurator.

Range ft(PSI)

Selects appropriate range for the transducer type.

High Set Point ft

For *Empty* and *Maintain Out* modes, sets the level that *begins* an autostart cycle. For *Fill* and *Maintain In* modes sets the level that *ends* the cycle.

Transducer	
→ Type	Level
Range ft(PSI)	23.1(10)
High Set Point ft	0.0
Maintain Point ft	0.0
Low Set Point ft	0.0
Dead Band ft	0.0

↑ ↓ - + ↶

Maintain Point ft

Sets the target point for maintain modes.

Low Set Point ft

For *Empty* and *Maintain Out* modes sets the level that *ends* an autostart cycle. For *Fill* and *Maintain In* modes sets the level that *begins* a cycle.

Dead Band ft

Sets the amount of change from the target point required to alter the engine speed.

STARTER

This submenu configures starter control options for autostart.

Restart Attempts

Selects the number of times to attempt restart.

Restart Delay

Selects the number of seconds to wait before attempting a restart.

Start On

Selects the maximum number of seconds the starter can be engaged.



SETTINGS MENU

This submenu allows the user to configure CANplus hardware.

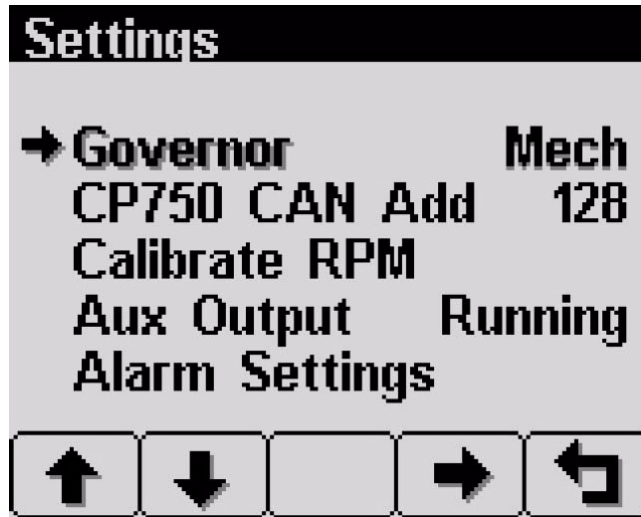

GOVERNOR

Selects between *Elect* (electronically governed) and *Mech* (mechanically governed) engines modes. For mechanically governed engines, the *CANplus I/O Board* functions as an ECU, broadcasting engine parameters such as oil pressure and temperature on the CANbus.

Note: Switching governor modes requires cycling power before calibrating the RPM. The *CANplus Configurator* must be used to configure mechanical engine parameters.

CP750 CAN ADD

Selects the address used by the display to communicate with the CANplus I/O board. The default I/O Board address is 128.

Note: Engine data is always transmitted using address 0 in mechanically governed mode.

⚠ WARNING





Incorrectly configuring the CP750 CAN Address prevents the display from receiving I/O Board data for the display menus and can result in data collisions on the CANbus.

CALIBRATE RPM

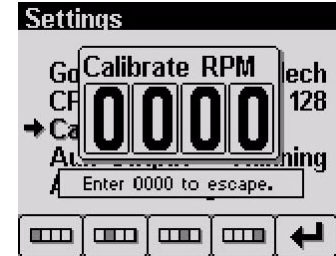
Calibrates the tachometer input for mechanically governed engines to allow the CANplus I/O board to measure the engine speed. This signal may be provided by an alternator frequency tap, proximity switch. An optional amplifier/divider can be added for use with a magnetic pickup.

Note: Calibrate RPM is only available on mechanically governed engines. The RPM must be calibrated for automatic start/stop operation to function.



Crank the engine and measure the engine RPM with a handheld tachometer. Select Calibrate RPM and enter the digits of the measured RPM using the buttons corresponding to the digits of the RPM. Button 1  adjusts the first digit of the RPM. Button 2  adjusts the second digit, button 3  the third digit and button 4  the fourth digit. The RPM is entered using button 5 .

When the calibration is complete, the LEDs will begin a blinking sequence. The power must be cycled to continue configuration or operation.

AUX OUTPUT

Selects the Aux Output function and provides a 1 amp low side switch.

RunningThe output is active when the engine RPM exceeds 500 RPM.

AS ArmedThe output is active when the keyswitch is in the Autostart position and the engine has not stopped due to a fault.

At SpeedThe output is active when the engine is at or above the Operating RPM.

PrestartThe output is prestart alarm activated 10 seconds before the engine automatically starts.

Note: The Aux Output is available on a connector in the I/O Board only. Changing the prestart alarm time requires using the LOFA Configurator.

ALARM SETTINGS

Configures the set points for the transducer alarm messages. The alarm is transmitted as SPN 1083 with FMI 1 for a low alarm and FMI 0 for a high alarm.

Low Level ft

Sets the transducer low level alarm set point.

High Level ft

Sets the transducer high level alarm set point.

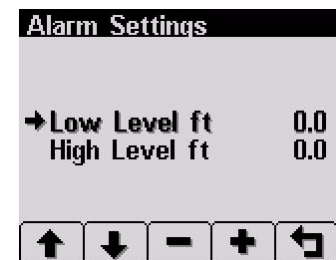

TELEMETRY MENU

This menu allows configuring the optional telemetry system.

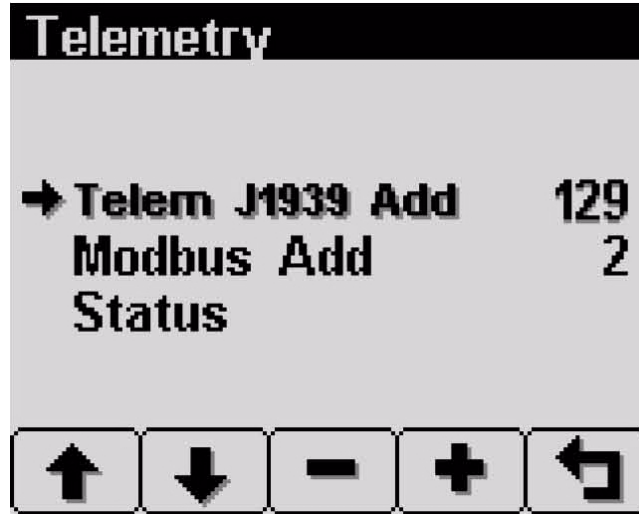

TELEM J1939 ADDRESS

Defines address the telemetry module is using for CANbus communications.

Note: The display will be unable to communicate with the telemetry module if this address is incorrect.

MODBUS ADDRESS

Selects the Modbus slave address the telemetry module will use for Modbus communications.

STATUS

Displays telemetry and modem status information retrieved from the telemetry module:

Modem Type Identifies the modem type

Cell Reg Identifies cell modem registration

Cell State Indicates cell state and signal strength

GPS Indicates GPS status

RTC Indicates number of days since real time clock cellular update

Modbus SSLT Indicates Modbus slave status

Hdw Status Indicates various hardware status items

Software Ver Indicates the version of software in the Messenger

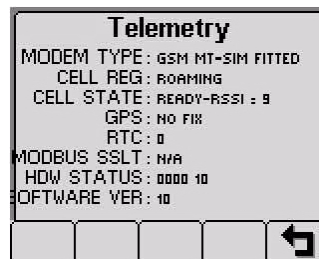



DB VIEWER

The Database Viewer displays and decodes all data monitored by the display. This diagnostic tool allows viewing data not normally displayed.

DISPLAY DATA BASE VIEWER	
EXT COOLANT PRESS:	16.4 PSI
FUEL DELIV PRESS:	30.5 PSI
FUEL LEVEL:	60 %
OIL PRESSURE:	49.2 PSI
TURBO PRESSURE:	29.0 PSI
AIR INLET PRESS:	28.0 PSI
BARO PRESSURE:	14 PSI
COOLANT TEMP:	182 °F
TRANS OIL PRESS:	234 PSI

Navigation buttons: ↑, ↓, [Empty], [Empty], ↶

The list can be scrolled using buttons 1  and 2  and closed by pressing Button 5 .

Note: The Database Viewer is always in English regardless of language selected.

PREFERRED SCREEN STORE

The display automatically stores the current screen as the preferred screen after a delay of approximately 15 seconds. The display will use the last stored screen on the next power-up.

Note: Selecting Restore Defaults restores the Analog Gauge Pages and default gauges.

POPOP MESSAGES AND ALERTS

SERVICE REQUIRED

Users can set up to sixteen service timers in hours in the Configuration menu. The Service Required popup is displayed at power up when one or more service timers has expired. Pressing any button removes the popup. If no button is pressed, the popup closes in approximately 5 seconds.

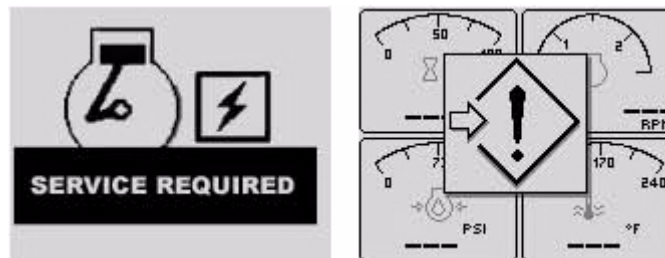

Pop-up warnings of service required and data communications failure.

DATA COMMUNICATIONS FAILURE



The data communications failure popup icon flashes if the display does not detect data. The warning disappears and normal operation resumes once data is detected.

Note: Incorrectly configuring the Engine Source address will result in no data available for display.

DATA NOT AVAILABLE

Gauges and the Db Viewer will display  if the desired data is not available. The display value returns to normal when parameter data is received.

ADJUSTING LIGHTING AND CONTRAST

Pressing button 5 (the right-hand button) when there is no menu bar opens the lighting and contrast menu bar. The display has a number of back-lighting levels allowing the display to be read in the dark. The level is adjusted by pressing button 1 to decrease, or button 2 to increase  illumination. Contrast is adjusted in the same manner using buttons 3 and 4 .

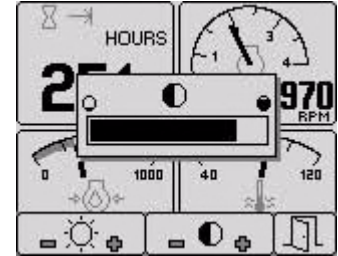

Note: The display adjusts the contrast with ambient temperature. Manual contrast adjustments are only necessary with extreme climate change.

The menu is exited by pressing button 5 . The lighting and contrast settings are retained after the unit is powered off.

Note: If the contrast has been adjusted poorly, the factory setting is restored by pressing buttons 1 thru 4 simultaneously. This action does not change other user-configured settings.

INDICATORS

AUTO STANDBY LED (GREEN)

A solidly illuminated *Auto Standby* LED indicates the keyswitch is in the auto start position and the system is ready to start.



PREHEAT LED (AMBER)

A solidly illuminated *Preheat* LED indicates the engine is preheating. When the LED extinguishes, the preheat period is complete and the engine may be cranked.

Note: The CANplus display only reports when the ECU is requesting preheat. Cold starting aids may not be installed in all engine configurations.



ENGINE STOP LED (RED)

A solidly illuminated *Engine Stop* LED indicates the ECU has stopped the engine due to a fault.

Note: ECU programming determines the response to warnings and failures. Typically the ECU can be programmed to shutdown, derate or run to failure. The CANplus display only displays ECU reported conditions.



























WARNING LED (AMBER)

A solidly illuminated *Warning* LED indicates a warning reported by the ECU.







Note: The *Warning LED* is not used in **Mechanical Governor** mode.

DATA PARAMETERS MONITORED

This table lists the engine and transmission parameters that are monitored via the CANbus. The parameters can be displayed by the user-configurable gauge pages or the single analog gauge. DB is an abbreviation for the internal database which stores all data transmitted from the engine/transmission. The complete database can be accessed on the display via the *Db Viewer* in the *Configuration* menu.

Icon	Parameter	Gauge Pages	Single Gauge	Database
	Electrical Potential	●	●	●
	Battery Voltage, Switched	●	●	●
	Net Battery Current	●		●
	Alternator Voltage	●	●	●
	Alternator Current	●	●	●
Fuel (L, Gal, lGal) or (L/h, Gal/h lGal/h) or km/L, MPG or IMPG)				
	Fuel Level	●	●	●
	Fuel Rate	●	●	●
	Fuel Temperature	●	●	●
	Instantaneous Fuel Economy	●		●
	Trip Fuel Economy	●		●
	Trip Fuel	●		●
	Trip Fuel Rate	●		●
	Total Fuel Used			●
	Fuel Leakage 1			●
	Fuel Leakage 2			●
Distance (km, Miles or Nmiles)				
	Distance Remaining	●		●
	Trip Distance	●		●
	Total Vehicle Distance	●		●
Pressure (kPa, PSI or bar)				
	Fuel Pressure	●		●
	Barometer Pressure	●		●
	Auxiliary Pressure 1	●		●
	Turbo Pressure	●	●	●
	Air Inlet Pressure	●		●
	Air Filter Differential Pressure	●		●
	Injector Metering Rail 1 Pressure	●		●
	Injector Metering Rail 2 Pressure	●		●
	Engine Coolant Pressure	●		●

Icon	Parameter	Gauge Pages	Single Gauge	Database
	Engine Oil Pressure	●	●	●
	Transmission Oil Pressure	●	●	●
	Clutch Pressure	●		●
	Air Start Pressure	●		●
	Injector Control Pressure	●	●	●
Temperature (°C, °F)				
	Engine Coolant Temperature	●	●	●
	Engine Intercooler Temperature	●		●
	Engine Oil Temperature	●	●	●
	Transmission Oil Temperature	●	●	●
	Turbo Oil Temperature	●		●
	Intake Manifold Temperature	●	●	●
	Air Inlet Temperature	●	●	●
	Exhaust Temperature	●	●	●
	Auxiliary Temperature 1	●	●	●
	Engine ECU Temperature			●
	Exhaust Gas Port 1 Temperature	●		●
	Exhaust Gas Port 2 Temperature	●		●
	Turbo Inlet Temperature	●		●
Percentage (%)				
	Acceleration Position	●		●
	Engine Oil Level	●	●	●
	Coolant Level	●	●	●
	Fan Speed	●		●
	Drivers Demand Percent Torque	●		●
	Actual Engine Percent Torque	●	●	●
	Percent Load at RPM	●	●	●
Speed (RPM, km/h, MPH or KTS)				
	Input Shaft Speed	●		●
	Output Shaft Speed	●		●
	Engine Speed	●	●	●
	Turbo 1 Speed	●		●
	Engine Desired Operating Speed	●		●
	Fan Speed	●		●

Icon	Parameter	Gauge Pages	Single Gauge	Database
	Vehicle Speed	●	●	●
Time (h)				
	Total Engine Hours	●		●
	Trip Engine Hours	●		●
	Service Hours			●
Miscellaneous				
	Torque Converter Lock-Up Engaged			●
	Transducer	●	●	●
	Current Gear	●		●
	Selected Gear	●		●
	CANTX Disable			●
	CANplus I/O			●

ENGINE BREAK-IN REQUIREMENTS

Note: During the first 20 hours of operation, avoid long periods of low engine speed or sustained maximum engine speed.

John Deere engine are supplied with engine break-in oil from the factory. Extra care during the first 100 hours of engine operation will result in better performance and longer engine life. DO NOT exceed 100 hours of operation with the break-in oil. Operate the engine at high engine speeds (60-90% of maximum) as much as possible. If the engine has spent significant time at idle, constant speeds and/or light load, or if makeup oil is required, a longer break-in period may be needed. Consult the engine operation and maintenance manual for a full description of necessary procedures on the addition of break-in oil and extension of the break-in period. Use the schedule table on [page 40](#) as a guide for regular maintenance intervals.

PUMP PRE-USE CHECKPOINTS

Before using the pump, be sure to check the following:

- Check that the unit is placed as close as possible to the liquid being pumped, keeping the number of hose sections and couplings to a minimum.
- Make sure the ground is firm and as level as possible.
- Check the pump discharge area; make sure discharge will not erode the material under the pump or damage any nearby structures.
- Make sure all hose couplings are of the same size and type.
- Check that all hoses/piping are supported, braced and lined up square before connection to the pump flanges. A flexible fitting is recommended on both suction and discharge, to eliminate misalignment loads or stresses being transmitted to the pump.

Note: Flexible pipe couplings must be restrained so as not to transmit any strain to the pump flanges when expanding or contracting under pressure. Unrestrained expansion fittings can transmit enormous forces to the pump flanges.

⚠ WARNING

The pump is designed to handle water and/or other liquids containing some slurries and other entrained solids up to a certain diameter (see the "SPECIFICATIONS" section on [page 9](#) for the correct diameter). It **MUST NOT** be used to pump volatile, corrosive or flammable materials that may damage the pump, cause pump failure or result in explosion. Serious personal injury could result!

PUMP SET UP

1. Place the unit on firm, level ground, as close as possible to the pumpage source. Provide adequate space for operation, maintenance and inspection of equipment. Make certain the unit is sitting level, to ensure proper fuel feed and distribution of engine lubricants.
2. Attach the preferred fittings to both the intake and outlet openings of the pump, making sure they match the fittings on the hoses. Make sure a gasket/seal is in place between the pump volute and the flange on the fitting being attached. Tighten all hardware completely to ensure an airtight seal. Threaded fittings require the use of pipe thread sealant.
3. Attach a rigid hose or pipe to the intake (suction) side of the pump. For best performance, the suction hose/piping should be at least as large as the pump flange, never smaller. The pump should be at the highest point of the hose/piping. All suction piping and fittings should be checked for any foreign material (rocks, bolts, wire, etc.) and also any sharp burrs that could disrupt the flow. Make sure the O-ring seal is present in the fitting on the pump before attaching the fitting. **Note:** *Lubricate the O-ring seal with grease to ensure an airtight seal.*

⚠ CAUTION

The suction and discharge pipe/hose material should be compatible with the liquid being pumped.

⚠ DANGER







IF A MANUAL SHUT-OFF VALVE IS INSTALLED IN THE DISCHARGE LINE, IT MUST NOT BE LEFT CLOSED DURING OPERATION. A CLOSED MANUAL SHUT OFF VALVE WILL CAUSE OVERHEATING AND POSSIBLE EXPLOSIVE RUPTURE OF THE PUMP CASING. PERSONNEL COULD BE SERIOUSLY INJURED!

4. Attach a rigid intake screen or strainer to the end of the fill hose before placing it in the liquid. This will prevent large items or excessive trash from entering the pump housing. The screen must have enough openings to equal four times the area of the intake hose (6 in x 3.14 = 18.84 sq in x 4 = 75.36 sq in [48,619.26 sq. mm]). The screen should be rigid enough to prevent collapse when flow is reduced due to clogging.
5. Place the intake hose into the liquid to be pumped. The submergence of the suction pipe into the liquid should be at least four to five times the pipe diameter. If this is not possible, provide a baffle or a floating board. This is to prevent any vortex action allowing air into the pipe/hose. For best performance, a bell mouth fitting is recommended. Refer to the Hydraulic Institute Handbooks or other Hydraulic Data books for detailed sump design information.
6. Attach a flexible hose to the outlet (discharge) side of the pump. Make sure the O-ring seal is present in the fitting on the pump before attaching the fitting. **Note:** *Lubricate the O-ring seal with grease to ensure an airtight seal.* Use a concentric taper on the discharge side to increase discharge pipe/hose diameters. All valving and additional fittings should be the same size as the discharge main-line. The discharge size should be adequate to maintain reasonable velocities and reduce friction losses.
7. Check the intake and outlet hoses for sharp bends or kinks that may restrict pump flow before proceeding. The intake hose should slope upwards toward the pump to avoid development of air pockets in the hose which may lead to pump cavitation. Keep the hoses as straight as possible.

The pump is now ready for use.

STARTING THE PUMP

Before starting the pump, be sure to check the following:

- Make sure all hose couplings, covers and plugs are tight.
 - Check the oil level in the mechanical seal oil sight tube, bearing oil sight glass, and vacuum pump sight glass.
 - Check the engine oil level, coolant level and fuel level.
 - Make sure the engine starting battery is connected.
1. Make sure the Emergency Stop switch is pulled out (deactivated).
 2. Turn the Engine Start Switch (key) to the right RUN position. A start-up screen will appear. After the start-up screen is cleared, the display will show readings on its virtual gauges. Once the gauges appear, crank the engine by turning and holding the key switch in the start position until the engine starts. See [page 13](#) for details.
 3. Allow the engine to run until it reaches a constant speed. Once it is running smoothly, the engine speed can be adjusted. Use the Speed Control Switch ( / ), located above the Engine Start Switch on the control panel, to adjust the engine speed:
 - a. Press and release the rabbit  icon to increase the speed.
 - b. Press and hold the rabbit  icon to accelerate to full speed in a few seconds.
 - c. Press and release the turtle  icon to decrease engine speed. (Press and hold for continuous deceleration.)
 4. The pump should prime and begin to discharge liquid within minutes. A high suction lift or low engine speed will require a longer time to prime and pump.
 5. Use the Speed Control Switch ( / ) to adjust the pump flow. Several factors can influence pump output:
 - The temperature, viscosity amount of entrapped solids in the liquid being moved.
 - The length, diameter and number of bends of the intake and outlet hoses.
 - The total suction height (lift) of the pump.
 - The altitude above sea level where the pump is operating.

⚠ WARNING

Never adjust the pump flow by attaching a valve to the intake or outlet side of the pump. Restricting the flow in this way can cause the pump to overheat, creating extreme pressure inside the pump volute. Explosion of the pump volute and serious personal injury may result!

6. The intake hose must be kept four to five times the hose diameter (4-5 x 6 in = 24-30 in) below the surface of the liquid being pumped.

7. Use the table below for approximate flow rates.

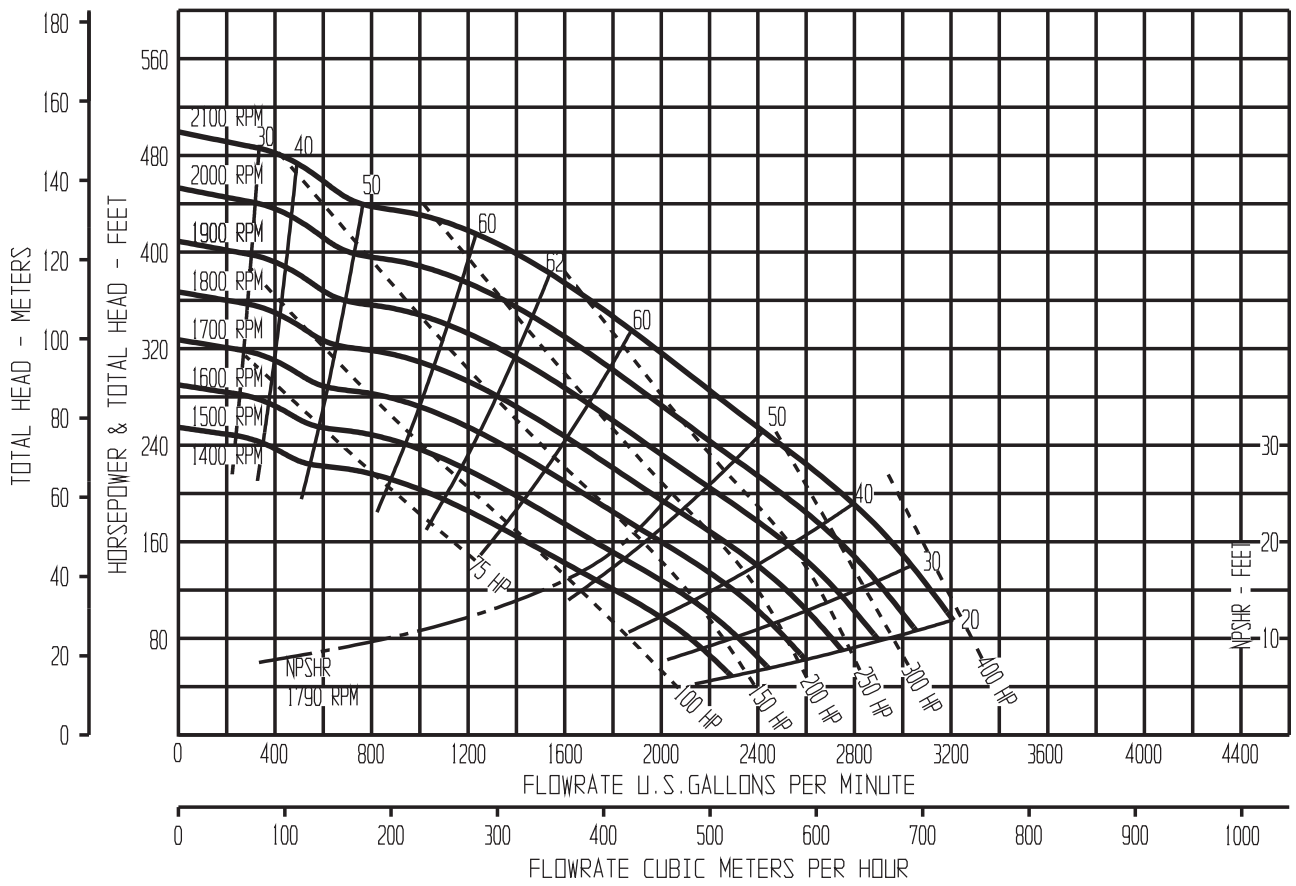

SUCTION SPECIFICATIONS

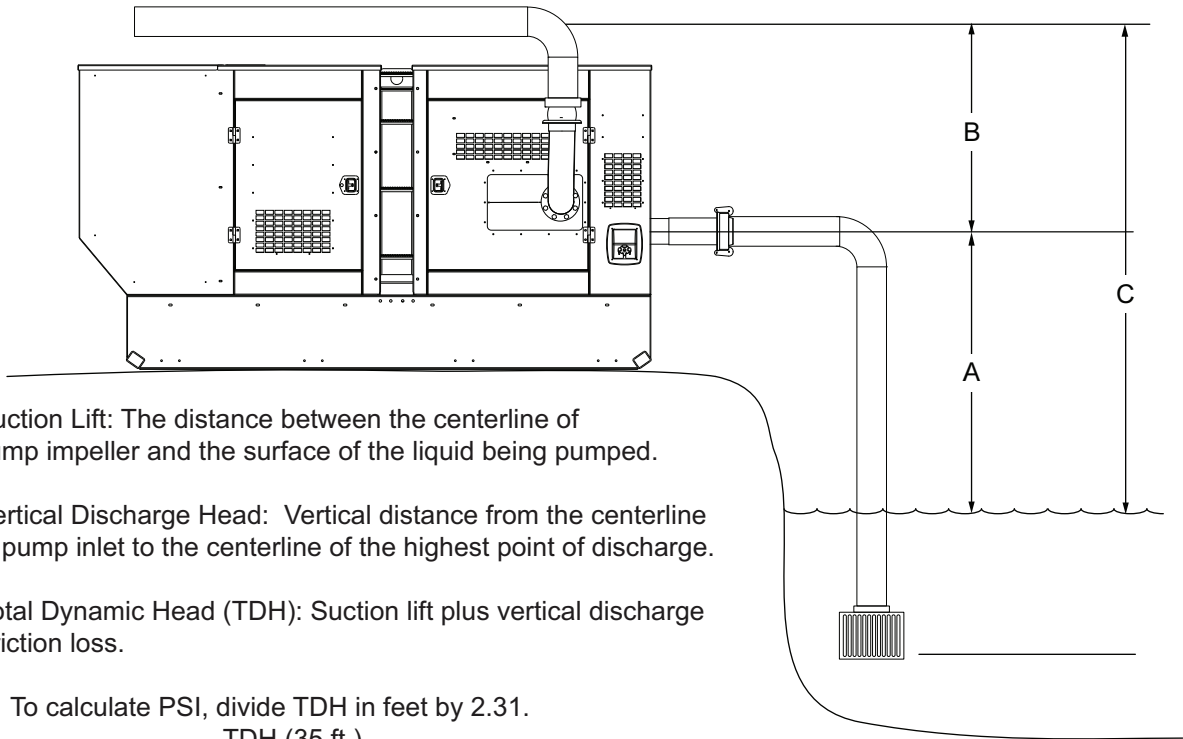

A = Suction Lift: The distance between the centerline of the pump impeller and the surface of the liquid being pumped.

B = Vertical Discharge Head: Vertical distance from the centerline of the pump inlet to the centerline of the highest point of discharge.

C = Total Dynamic Head (TDH): Suction lift plus vertical discharge plus friction loss.

Note: To calculate PSI, divide TDH in feet by 2.31.

$$\text{Example: } \frac{\text{TDH (35 ft.)}}{2.31} = 15.15 \text{ PSI}$$

STOPPING THE PUMP

1. Reduce the engine speed by adjusting the speed control switch .
2. Allow the engine to idle briefly before switching the engine start switch to the OFF position.

NOTICE

Do not use the Emergency Stop switch unless absolutely necessary. Stopping the pump suddenly may cause shock waves to be transmitted back to the pump volute, causing pump damage. To activate the emergency stop, push the stop switch in. To deactivate the switch, pull the switch out.

3. The pump is adequately prepared for outside storage. See [“Storage” on page 42](#) for additional extended storage suggestions.

⚠ CAUTION

In freezing temperatures, drain the pump volute case of pumpage when the unit is idle to avoid freezing and possible equipment damage. Also, clean out any solids by flushing with a hose.

AUTOMATIC SHUTDOWN

The pump is equipped with a low oil pressure and a high temperature automatic shutdown system. This system will automatically shut off the fuel supply to stop the engine if oil pressure drops too low or the engine exceeds normal operating temperature. Return the engine start switch to the “OFF” position to reset the controller; restart the pump engine after you have determined the cause of the shutdown. Refer to [“Engine Fault Shutdown Troubleshooting” on page 44](#) for more information.

REMOTE/AUTO STARTING

The pump can be configured to start automatically by adding dry-contact closure float level switches. Contact the Magnum Power Products LLC Technical Service Department at 1-800-926-9768 for more information.

LIFTING THE PUMP

Only lift the pump with equipment that is in good condition and that is rated to support the weight of the pump. See the specifications on [page 9](#) for approximate weights. A large central lifting eye is located on the top of the pump. The eye is connected to a central lifting frame. Attach a sling or hook directly to the lifting eye. Always remain aware of others around you when moving or lifting the pump. Suction and discharge hoses and piping must be removed from the pump before lifting.

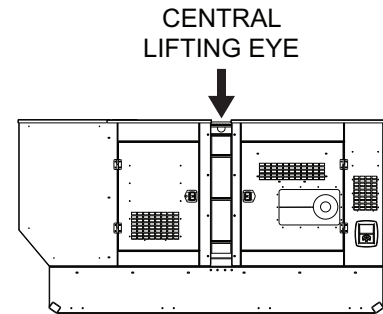

DAILY WALK AROUND INSPECTION

Look for conditions that could hinder performance or safety, such as (but not limited to) oil/coolant/fuel leakage, blocked vents, loose/missing hardware and electrical connections.

Visually inspect the engine fan belt for cracks, fraying, stretching and that the belt is properly seated in pulley grooves. Replace the belt according to the manufacturer's recommendations.

Note: At the 500 hour/12 month service interval, it is recommended that the belt be removed and checked for wear. While the belt is removed, inspect pulleys and bearings. Rotate and feel for hard turning or unusual sounds. If pulleys or bearings need replacement, contact John Deere.

NOTICE

Failure to perform a daily inspection may result in serious damage to the prime mover.

ENGINE AND PUMP MAINTENANCE

Poorly maintained equipment can become a safety hazard! In order for the equipment to operate safely and properly over a long period of time, periodic maintenance and occasional repairs are necessary. NEVER perform even routine service (oil/filter changes, cleaning, etc.) unless all electrical components are shut off. When servicing this equipment, always follow the instructions listed below:

- Make sure the engine start switch is turned to the “OFF” position.
- Activate (push in) the emergency stop switch.
- Disconnect the negative (-) terminal on the battery.
- Make sure engine and pump components are adequately cooled.
- Attach a “DO NOT START” sign to the control panel. This will notify everyone that the unit is being serviced and will reduce the chance of someone inadvertently trying to start the unit.
- Never wash the unit with a high pressure hose or with any kind of power washer.
- Never wash the engine block or fuel tank with a power washer or steam cleaner. Water may collect in the control panel or other electrical parts, causing damage.

BASIC MAINTENANCE SCHEDULE (JOHN DEERE ENGINE)

NOTICE

Refer to the original equipment manufacturer’s operating manual for a complete list of maintenance requirements. Failure to comply with the procedures as described in the engine operator manual will nullify the warranty, decrease performance and cause equipment damage or premature equipment failure.

Use the schedule in the following table as a guide for regular maintenance intervals. For additional or replacement copies of the engine operator’s manual, contact an authorized dealer in your area.

Maintenance Action	DAILY	250 HRS.	500 HRS./12 Months	2000 HRS./ 24 Months	As Required
Check oil level	◆				
Check coolant level	◆				
Check fuel level	◆				
Check tire pressure	◆				
Check all electrical connections	◆				
Inspect radiator fins for debris, clean as required	◆				
Check fuel filter	◆				
Check air cleaner dust unloader valve and indicator	◆*				
Perform visual walkaround inspection	◆				
Check mechanical seal oil level (page 42)	◆				
Check flange fitting hardware	◆				
Check condition of wear plate		◆			
Change mechanical seal oil (page 42)		◆			
Check condition of volute seals		◆			
Lubricate pump bearings (page 42)		◆			
Check oil vapor recirculation system/non-return valve		◆			
Replace oil vapor recirculation filter			◆		
Change engine oil and replace oil filter			◆**		

Maintenance Action	DAILY	250 HRS.	500 HRS./12 Months	2000 HRS./ 24 Months	As Required
Replace fuel filter element			◆		
Check air intake system			◆		
Check belt tensioner spring tension and belt wear			◆		
Check engine electrical ground connection			◆		
Check engine mounts			◆		
Service battery			◆		
Check cooling system			◆		
Lubricate leveling jack(s)			◆		
Check compressor mounting hardware			◆		
Test thermostats				◆	
Check flex coupling condition				◆	
Check pump to engine hardware				◆	
Add coolant					◆
Replace air cleaner elements					◆
Replace alternator and fan belts					◆
Check fuses					◆
Bleed fuel system					◆

* *Replace primary air cleaner when dust valve restriction indicator gauge shows a vacuum of 25 in. H₂O or at least every 500 hours. Some operating environments will require more frequent changes.*

** *Change the oil and oil filter after the first 100 hours, then every 500 hours. If John Deere Plus-50 II oil or equivalent is not used, the oil must be changed every 250 hours.*

BELT TENSION

John Deere engines use two types of belt tensioners: manual and automatic. Adjust the belt using the manual tensioner according to the manufacturer's specifications. The automatic tensioner cannot be adjusted or repaired and is designed to maintain proper tension over the belt's life. Units with the automatic belt tensioner must be inspected according to the manufacturer's specifications.

SERVICING THE PUMP

Refer to the Pioneer Pump Operation & Maintenance Manual (#1501) for detailed pump safety, service, and maintenance procedures.

▲ WARNING

Before attempting to service the pump, read and understand the Pioneer Pump Operation & Maintenance Manual (#1501) that was provided with the unit. Operating and maintenance personnel should understand all aspects of the pump and pumping conditions. Failure to understand the provided information could contribute to equipment damage, bodily injury or possible death.

Before servicing:

1. Verify that the engine start switch is turned to the "OFF" position and the negative (-) cable on the battery is disconnected.

2. If the pump or components are hot, allow adequate cooling prior to servicing the unit.
3. Close the suction and discharge valves.
4. Vent the pump slowly and drain completely.

Refer to the troubleshooting section on [page 43](#) to help diagnose operational or performance problems. Only disassemble the pump components required to remedy the problem condition.

Select a clean suitable location for any required maintenance, and note that all work must be performed by qualified personnel. An ongoing record of performance will assist in any troubleshooting and/or analysis of problems. A pressure gauge can be installed on the suction and discharge side of the pump to monitor any changes in differential pressure. Differential pressure is useful in monitoring and diagnosing any possible degradation in pump performance.

LUBRICATION - BEARING FRAME

The bearing frame is oil lubricated. An oil level gauge is attached to the bearing frame and marked at the factory for proper oil level. ISO viscosity grade 32 turbine oil is installed at the factory. This oil is suitable for a wide range of temperatures. However, during operation, temperature measurements should be taken on the bearing frame at the oil sump location. If the indicated temperature is greater than 160°F (71°C), then the oil should be changed to an ISO viscosity grade 68 turbine oil at the next maintenance interval. Oil should be changed approximately every three months of continuous operation.

LUBRICATION - MECHANICAL SEAL OIL RESERVOIR

This pump is provided with a seal oil reservoir that permits this unit to run dry. The reservoir supplies lubrication and cooling to the outboard side of the mechanical seal without any liquid in the pump. Monitor the oil level sight gauge (tube) and add oil as indicated. During normal operation it is suggested to change this oil every three months. If the sight gauge shows indication of contamination or discoloration, change oil more frequently. The external oil reservoir is filled via a plug on the top of the tank. There is a petcock located on the opposite side of the run-dry gland from the oil inlet line. During initial filling, this petcock should be opened to allow the air to vent from the gland. Use turbine oil with an ISO rating of 32 or lower. If you have unusual pumping conditions, consult Magnum Power Products LLC. Oil used in the reservoir should be ISO VG 32 Turbine Oil or automatic transmission oil, equivalent to one of the following manufacturer's products: Chevron Turbine Oil GST 32, Mobile DTE 797, Shell Turbo T Oil 32.

LUBRICATION - VACUUM PUMP

The oil level in the vacuum pump crankcase should be in the center of the oil level sight glass. A 30 wt, non-detergent motor oil should be used. During normal operation it is suggested to change this oil every three months.

STORAGE

The unit is adequately prepared for outside storage prior to shipment. Use the following list of additional suggestions for extended storage.

1. Disconnect the battery cables.
2. Store the unit off the ground so no water will accumulate around the equipment.
3. Protect the unit from blowing sand and dirt.
4. Stack no other items on top of the pump/equipment.
5. Protect the unit from the entry of any animals.
6. Periodically rotate the shaft to lubricate the bearings and protect them from brinelling.
7. Protect the unit with approved drying agents (Silica Gel).
8. Ensure all bare metal areas are coated with a rust preventative.
9. Inspect the unit every four weeks and replace drying agents (Silica Gel) as required, or a minimum of every six months.
10. Keep an inspection record showing dates of inspection with any maintenance performed and condition of drying agents (Silica Gel).
11. Before use, ensure that all rust protection has been removed. Also, remove any foreign material that may have accumulated during storage.
12. Before use remove all drying agents (Silica Gel).

PUMP TROUBLESHOOTING

Symptom	Possible Cause
No discharge	1,2,3,4,5,7,8,9,10,17,18,19,20,37
Reduced capacity	2,3,4,5,7,8,9,10,11,17,19,20,21,38,39,40,47
Reduced pressure	5,7,8,11,13,18,19,38,39,40,47
Loss of prime	2,3,4,7,10,11,20,21,22,23
Power consumption excessive, engine runs hot	6,12,13,17,18,19,24,33,34,35,36,37,38,41,42,43,44
Vibration and noise	2,4,9,10,14,15,17,26,27,28,29,30,31,32,33,34,35,36,39,40,41,42,43,44,48
Seal: excessive leakage, short life, seal housing over-heating	22,23,25,33,34,35,36,41,44,45,46
Bearings: overheating, short life, noise	26,27,28,29,30,31,32,33,34,35,36,41,42,43,44
Pump overheating, seizes	1,8,9,14,33,34,35,36,41,42,43,44
Corrosion, erosion, pitting, oxidation or other loss of material	7,8,11,14,15,16

- | | | |
|---|--|---|
| 1. Pump not primed | 16. Electrolysis | 34. Temperature growth |
| 2. Suction line not filled | 17. Impeller obstructed | 35. Misalignment |
| 3. Air pocket in suction line | 18. Rotation direction wrong | 36. Coupling improperly installed |
| 4. Suction inlet or foot valve obstructed, insufficiently submerged, or too small | 19. Low speed | 37. Impeller installed backwards |
| 5. System head higher than pump design head | 20. Air leak into suction line | 38. Worn wear rings |
| 6. System head lower than pump design head | 21. Air leak through mechanical seal | 39. Impeller damage |
| 7. Insufficient NPSH | 22. Seal fluid contaminated, hot or insufficient | 40. Improper balance (after repair) |
| 8. Parallel pump application is incorrect | 23. Seal fluid system not vented | 41. Bent shaft |
| 9. Suction pressure to vapor pressure below minimum | 24. High speed | 42. Excessive thrust |
| 10. Suction lift too high | 25. Mechanical seal insufficient | 43. Rotational element dragging |
| 11. Excess vapor in pumpage | 26. Bearing housing excessively cooled | 44. Worn or incorrectly installed bearings |
| 12. Specific gravity of pumpage housing different than design | 27. Low oil pressure (oil lube bearings) | 45. Mechanical seal not properly set, O-rings damaged or hardened |
| 13. Viscosity of pumpage different than design | 28. Improper or poor lubrication | 46. Shaft scored at seal |
| 14. Operation at below rated capacity | 29. Lubrication defective | 47. Volute O-ring |
| 15. Cavitation | 30. Dirt in lubrication/bearings | 48. Foundation not rigid or settle |
| | 31. Moisture in lubricant/bearing housing | |
| | 32. Lubricant excess | |
| | 33. Pipe strain | |

ENGINE FAULT SHUTDOWN TROUBLESHOOTING

Symptom	Possible Cause	Solution
Low oil pressure shutdown	Low oil level	Check oil level, replace as necessary
	Faulty oil pressure sender	Replace oil pressure sender
	Incorrect oil grade	Change engine oil, consult engine operating manual
	Worn oil pump	Consult engine operating manual
	Oil leak	Consult engine operating manual
High temperature shutdown	Low coolant level	Check coolant level, replace as necessary
	Faulty temperature sender	Replace temperature sender
	Coolant leaks	Consult engine operating manual, replace components as necessary
	Worn water pump	Consult engine operating manual
Overcrank shutdown	Pump engine will not start	Consult engine operating manual
Overspeed shutdown	Pump cavitation	Reduce engine speed, lower intake hose
	Air trapped in intake hose	Relocate and/or straighten intake hose
	Intake insufficiently submerged	Lower intake hose
	Air leak in intake hose	Inspect intake hoses and couplings for damage or missing components and seals
	Air leak at pump housing	Inspect gaskets, seals and o-rings at pump intake flange, cleanout cover and priming port
No speed signal shutdown	Engine magnetic pickup damaged or misaligned	Inspect magnetic pickup for damage/alignment
Low fuel shutdown	Low fuel level	Refill fuel tank with clean diesel fuel
Low coolant shutdown	Low coolant level	Allow engine to cool. Check coolant level in radiator. Add coolant until it is 3/4" below the filler neck

CONTROL SYSTEM TROUBLESHOOTING

Symptom	Possible Cause	Solution
Control system does not perform self test	Tripped overcurrent protection	Correct fault, replace or reset overcurrent protection
	Faulty connection to battery	Correct battery connections
	Faulty control system	Repair or replace control system
Control system performs normal self test, engine cranks, runs and shuts down	Engine stop LED illuminated	Correct ECU stop condition, use ECU diagnostics
Display does not display data	Display lost power	Turn on key, verify display plugged into harness
	Engine source address incorrect	Change engine address in <i>Configuration</i>
	Display address incorrect	Change display address to 40 (default)
	Display configuration problem	Reset display using <i>Restore Defaults</i>
	CANbus failure	Check CANbus (see <i>Testing CANbus</i>)
	ECU not sending data	Repair or replace ECU

DC WIRING DIAGRAM

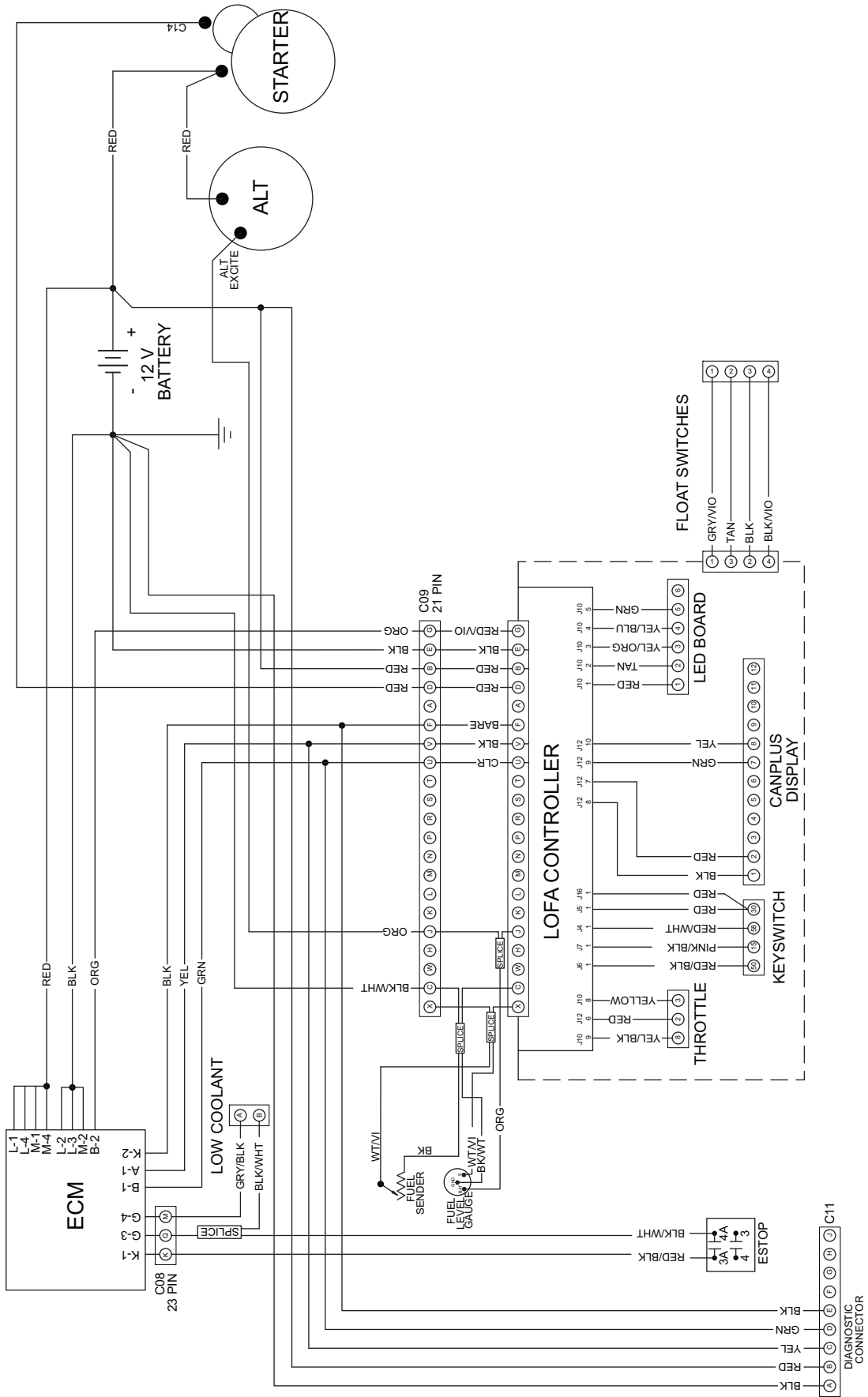

REV: A
PART NO: 31133
02.28.13